

## WEFATHERM PP-R Piping System

The Wefatherm PP-R System is ideally suited for use in a wide range of applications including hot and cold water systems, industrial heating and cooling, air-conditioning systems and compressed air networks. PP-R is the ideal replacement for traditional materials such as copper, steel and galvanised piping.

### Benefits



- Light weight, Non-toxic, Corrosion resistant
- Low pressure loss, Reduced noise
- Low thermal conductivity
- Fusion welded joints, Simple and economical installation



### Range

- Complete product range, 20mm to 160mm
- PN10, PN16, PN20, fibre pipe and stabipipe
- Made in Germany to the highest international standards

Related Documents: Machines & Tooling - Product Range

### WEFATHERM PIPE

|  | CODE:  | SIZE (OD)<br>mm | Wall<br>Thickness | PRICE |
|--|--------|-----------------|-------------------|-------|
| <b>PP-R80 Pipe<br/>SDR11 (PN10)</b><br>             | G20050 | 20              | 1.9               |       |
|  | G20051 | 25              | 2.3               |       |
|  | G20052 | 32              | 2.9               |       |
|  | G20053 | 40              | 3.7               |       |
|  | G20054 | 50              | 4.6               |       |
|  | G20055 | 63              | 5.8               |       |
|  | G20056 | 75              | 6.8               |       |
|  | G20057 | 90              | 8.2               |       |
|  | G20058 | 110             | 10.0              |       |
|  | G20059 | 125             | 11.4              |       |
| <b>Cold Water Pipe<br/>4 metre lengths</b>   |        |                 |                   |       |
| <b>PP-R80 Pipe<br/>SDR7.4 (PN16)</b><br>          | G20101 | 20              | 2.8               |       |
|  | G20102 | 25              | 3.5               |       |
|  | G20103 | 32              | 4.4               |       |
|  | G20104 | 40              | 5.5               |       |
|  | G20105 | 50              | 6.9               |       |
|  | G20106 | 63              | 8.6               |       |
|  | G20107 | 75              | 10.3              |       |
|  | G20108 | 90              | 12.3              |       |
|  | G20109 | 110             | 15.1              |       |
|  | G20110 | 125             | 17.1              |       |
| G20111   | 160    | 21.9            |                   |       |
| *G20180  | 200    | 18.2            |                   |       |
| <b>*PP-R CT SDR11<br/>Hot &amp; Cold Water Pipe<br/>4 metre lengths</b>  |        |                 |                   |       |
| <b>PP-R80 Pipe<br/>SDR11 (PN10)<br/>Lilac</b><br> | L20050 | 20              | 1.9               |       |
|  | L20051 | 25              | 2.3               |       |
|  | L20052 | 32              | 2.9               |       |
|  | L20053 | 40              | 3.7               |       |
|  | L20054 | 50              | 4.6               |       |
|  | L20055 | 63              | 5.8               |       |
|  | L20056 | 75              | 6.8               |       |
|  | L20057 | 90              | 8.2               |       |
|  | L20058 | 110             | 10.0              |       |
|  | L20059 | 125             | 11.4              |       |
| <b>Recycled Water Pipe<br/>4 metre lengths</b>   |        |                 |                   |       |

|  | CODE:                                     | SIZE (OD)<br>mm | Wall<br>Thickness | PRICE |
|--|---|-----------------|-------------------|-------|
| <b>Fibre Pipe<br/>SDR7.4</b><br>           | G20150                                    | 20              | 2.2               |       |
|  | G20151                                    | 25              | 3.5               |       |
|  | G20152                                    | 32              | 4.4               |       |
|  | G20153                                    | 40              | 5.5               |       |
|  | G20154                                    | 50              | 6.9               |       |
|  | G20155                                    | 63              | 8.6               |       |
|  | G20156                                    | 75              | 10.3              |       |
|  | G20157                                    | 90              | 12.3              |       |
|  | G20158                                    | 110             | 15.1              |       |
|  | G20159                                    | 125             | 17.1              |       |
|  | G20160                                    | 160             | 21.9              |       |
|  | <b>Hot Water Pipe<br/>4 metre lengths</b> |                 |                   |       |
| <b>WEFAKlim Fibre Pipe<br/>SDR11</b><br> | * 20130                                   | 20              | 2.8               |       |
|  | * 20131                                   | 25              | 3.5               |       |
|  | 20132                                     | 32              | 2.9               |       |
|  | 20133                                     | 40              | 3.7               |       |
|  | 20134                                     | 50              | 4.6               |       |
|  | 20135                                     | 63              | 5.8               |       |
|  | 20136                                     | 75              | 6.8               |       |
|  | 20137                                     | 90              | 8.2               |       |
|  | 20138                                     | 110             | 10.0              |       |
|  | 20139                                     | 125             | 11.4              |       |
| 20140  | 160                                       | 14.5            |                   |       |
| <b>*SDR7.4<br/>Mechanical Services Pipe (HVAC)<br/>4 metre lengths</b>   |   |                 |                   |       |

PRICES INDICATED DO NOT INCLUDE GST



### Asmuss Plastic Systems Limited

FREEPHONE: 0800 000 546 Facsimile: (64) (9) 477 - 2328

sales@plasticsystems.co.nz

34 Arrenway Drive, North Shore City 0632



P.O. Box 100244, North Shore City 0745, Auckland, NZ









Pipe • Fittings • Valving • Measurement & Control

[www.plasticsystems.co.nz](http://www.plasticsystems.co.nz)



**WEFATHERM SOCKET FUSION FITTINGS**







|  | CODE:   | SIZE (OD mm) | PRICE    |  |
|--|---|--------------|----------|--|
| <b>Socket</b><br><br>             | G27002  | 20           |          |  |
|  | G27003  | 25           |          |  |
|  | G27004  | 32           |          |  |
|  | G27005  | 40           |          |  |
|  | G27006  | 50           |          |  |
|  | G27007  | 63           |          |  |
|  | G27008  | 75           |          |  |
|  | G27009  | 90           |          |  |
|  | G27010  | 110          |          |  |
|  | G27011  | 125          |          |  |
|  | <b>Tee 90°</b><br><br> | G24002       | 20       |  |
| G24003   |   | 25           |          |  |
| G24004   |   | 32           |          |  |
| G24005   |   | 40           |          |  |
| G24006   |   | 50           |          |  |
| G24007   |   | 63           |          |  |
| G24008   |   | 75           |          |  |
| G24009   |   | 90           |          |  |
| G24010   |   | 110          |          |  |
| G24011   |   | 125          |          |  |
| *G24012  |   | 160          |          |  |
| **G24014   |   | 200          |          |  |
| <b>Reducing Tee 90°</b><br><br> |   | G25003       | 25x20x25 |  |
|  |   | G25004       | 32x20x32 |  |
|  | G25005  | 32x25x32     |          |  |
|  | G25006  | 40x20x40     |          |  |
|  | G25007  | 40x25x40     |          |  |
|  | G25008  | 40x32x40     |          |  |
|  | G25009  | 50x25x50     |          |  |
|  | G25010  | 50x32x50     |          |  |
|  | G25011  | 50x40x50     |          |  |
|  | G25012  | 63x20x63     |          |  |
|  | G25013  | 63x25x63     |          |  |
|  | G25014  | 63x32x63     |          |  |
|  | G25015  | 63x40x63     |          |  |
|  | G25016  | 63x50x63     |          |  |
| G25017   | 75x20x75  |              |          |  |
| G25018   | 75x25x75  |              |          |  |
| G25019   | 75x32x75  |              |          |  |
| G25020   | 75x40x75  |              |          |  |
| G25021   | 75x50x75  |              |          |  |
| G25022   | 75x63x75  |              |          |  |
| G25023   | 32x32x25  |              |          |  |
| G25024   | 25x20x20  |              |          |  |
| G25025   | 20x25x25  |              |          |  |
| G25026   | 30x20x25  |              |          |  |
| G25028   | 32x25x25  |              |          |  |
| G25029   | 50x20x50  |              |          |  |
| G25032   | 90x63x90  |              |          |  |
| G25033   | 90x75x90  |              |          |  |
| G25034   | 110x63x110  |              |          |  |
| G25035   | 110x75x110  |              |          |  |
| G25036   | 110x90x110  |              |          |  |
| G25037   | 125x75x125  |              |          |  |
| G25038   | 125x90x125  |              |          |  |
| G25039   | 125x110x125   |              |          |  |
| *G25044  | 160x90x160  |              |          |  |
| *G25045  | 160x110x160   |              |          |  |

|  | CODE:   | SIZE (OD mm) | PRICE |
|--|---|--------------|-------|
| <b>Overbridge Bow</b><br><br>        | G20501  | 20           |       |
|  | G20502  | 25           |       |
|  | G20503  | 32           |       |
|  |   |              |       |
| <b>Elbow 90°</b><br><br>              | G21002  | 20           |       |
|  | G21003  | 25           |       |
|  | G21004  | 32           |       |
|  | G21005  | 40           |       |
|  | G21006  | 50           |       |
|  | G21007  | 63           |       |
|  | G21008  | 75           |       |
|  | G21009  | 90           |       |
|  | G21010  | 110          |       |
|  | G21011  | 125          |       |
|  | *G21012   | 160          |       |
|  | **G21014  | 200          |       |
| <b>Elbow 90° Female/Male</b><br><br> | G22001  | 20           |       |
|  | G22002  | 25           |       |
|  | G22003  | 32           |       |
| <b>Long Bend 90°</b><br><br>        | G21101  | 20           |       |
|  | G21102  | 25           |       |
|  | G21103  | 32           |       |
|  | G21104  | 40           |       |
|  |   |              |       |
| <b>Elbow 45°</b><br><br>            | G23002  | 20           |       |
|  | G23003  | 25           |       |
|  | G23004  | 32           |       |
|  | G23005  | 40           |       |
|  | G23006  | 50           |       |
|  | G23007  | 63           |       |
|  | G23008  | 75           |       |
|  | G23009  | 90           |       |
|  | G23010  | 110          |       |
|  | G23011  | 125          |       |
|  | *G23012   | 160          |       |
|  | **G23014  | 200          |       |
|  | <b>Elbow 45° Female/Male</b><br><br> | G22100       | 20    |
| G22101   |   | 25           |       |
| G22102   |   | 32           |       |
| <b>Cross</b><br><br>                | G25101  | 32           |       |
|  | G25102  | 40           |       |
|  | G25103  | 50           |       |
|  | G25104  | 63           |       |
|  |   |              |       |

PN16 Rated

**WEFATHERM SOCKET FUSION FITTINGS CONT...**

|  | CODE:   | SIZE (OD mm) | PRICE |
|--|---------|--------------|-------|
| <b>Reducer</b><br>                              | G26003  | 25x20        |       |
|  | G26004  | 32x20        |       |
|  | G26005  | 32x25        |       |
|  | G26006  | 40x20        |       |
|  | G26007  | 40x25        |       |
|  | G26008  | 40x32        |       |
|  | G26009  | 50x20        |       |
|  | G26010  | 50x25        |       |
|  | G26011  | 50x32        |       |
|  | G26012  | 50x40        |       |
|  | G26013  | 63x40        |       |
|  | G26014  | 63x25        |       |
|  | G26015  | 63x32        |       |
|  | G26016  | 63x50        |       |
|  | G26017  | 75x50        |       |
|  | G26018  | 75x63        |       |
|  | G26019  | 90x63        |       |
|  | G26020  | 90x75        |       |
|  | G26025  | 110x90       |       |
|  | G26026  | 125x110      |       |
| *G26032  | 160x110 |              |       |
| *G26033  | 160x125 |              |       |
| **G26034   | 200x160 |              |       |
| <b>*Spigot</b><br><b>**SDR11</b>   |         |              |       |
| <b>Weld-in-saddle With Welding Socket</b><br> | G28052  | 40x20        |       |
|  | G28053  | 40x25        |       |
|  | G28054  | 50x20        |       |
|  | G28055  | 50x25        |       |
|  | G28056  | 63x20        |       |
|  | G28057  | 63x25        |       |
|  | G28058  | 75x20        |       |
|  | G28059  | 75x25        |       |
|  | G28060  | 90x20        |       |
|  | G28061  | 90x25        |       |
|  | G28062  | 110x20       |       |
|  | G28063  | 110x25       |       |
|  | G28064  | 125x20       |       |
|  | G28065  | 125x25       |       |
| G28066   | 125x32  |              |       |
| <b>End Cap</b><br>                            | G28002  | 20           |       |
| G28003   | 25      |              |       |
| G28004   | 32      |              |       |
| G28005   | 40      |              |       |
| G28006   | 50      |              |       |
| G28007   | 63      |              |       |
| G28008   | 75      |              |       |
| G28009   | 90      |              |       |
| G28010   | 110     |              |       |
| G28011   | 125     |              |       |
| *G28012  | 160     |              |       |
| **G28014   | 200     |              |       |
| <b>*Spigot</b><br><b>**SDR11</b>   |         |              |       |



|  | CODE:  | SIZE (OD mm)   | PRICE |
|--|--|--|-------|
| <b>Manifold Distributor</b><br>                    | G20602   | 32-20x4  |       |
| <b>Manifold Distributor With Female Thread</b><br> | G20604<br>G20606   | 32-1/2x4<br>40-1/2x4   |       |
| <b>Manifold Distributor With Male Thread</b><br>   | G20608<br>G20610   | 32-1/2x4<br>40-1/2x4   |       |
| <b>Pin For Pipe Repair</b><br>                     | G28030   | 7x11   |       |
| <b>Pipe Clip</b><br>                             | G34401<br>G34402<br>G34403   | 20<br>25<br>32   |       |
| <b>Pipe Clamp Single M10 Thread</b><br>           | 34201<br>34202<br>34203<br>34204<br>34205<br>34206<br>34207<br>34208<br>34209<br>34210<br>34212<br>34213 | 20<br>25<br>32<br>40<br>50<br>63<br>75<br>90<br>110<br>125<br>160<br>200 |       |



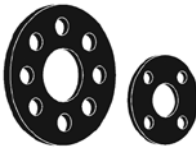



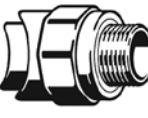
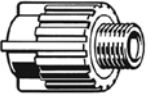
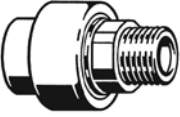
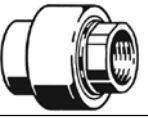
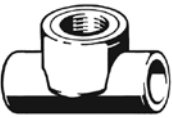
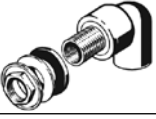

**WEFATHERM TRANSITION FITTINGS**

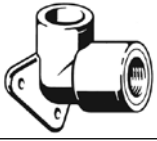
|   | CODE:                            | SIZE (OD mm) | PRICE |
|---|----------------------------------|--------------|-------|
| <b>Stub Flange With Seal</b><br> | G28020                           | 32           |       |
|   | G28021                           | 40           |       |
|   | G28022                           | 50           |       |
|   | G28023                           | 63           |       |
|   | G28024                           | 75           |       |
|   | G28025                           | 90           |       |
|   | G28026                           | 110          |       |
|   | G28027                           | 125          |       |
|   | *G28028                          | 160          |       |
|   | **G28029                         | 200          |       |
|   | <b>*Spigot</b><br><b>**SDR11</b> |              |       |

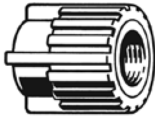





|  | CODE: | SIZE (OD mm) | PRICE |
|--|-------|--------------|-------|
| <b>Flange Din Bolt Pattern</b><br> | 28040 | 32           |       |
|  | 28041 | 40           |       |
|  | 28042 | 50           |       |
|  | 28043 | 63           |       |
|  | 28044 | 75           |       |
|  | 28045 | 90           |       |
|  | 28046 | 110          |       |
|  | 28047 | 125          |       |
|  | 28048 | 160          |       |

**WEFATHERM TRANSITION FITTINGS CONT...**

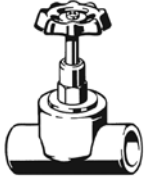
|   | CODE:  | SIZE (OD mm)          | PRICE |
|---|--------|-----------------------|-------|
| <b>Weld-in Saddle With Female Thread</b><br><br>       | G28071 | 40x1/2"               |       |
|   | G28072 | 50x1/2"               |       |
|   | G28073 | 63x1/2"               |       |
|   | G28074 | 75x1/2"               |       |
|   | G28075 | 90x1/2"               |       |
|   | G28076 | 110x1/2"              |       |
|   | G28077 | 125x1/2"              |       |
|   | G28171 | 40x3/4"               |       |
|   | G28172 | 50x3/4"               |       |
|   | G28173 | 63x3/4"               |       |
|   | G28174 | 75x3/4"               |       |
|   | G28175 | 90x3/4"               |       |
|   | G28176 | 110x3/4"              |       |
|   | G28177 | 125x3/4"              |       |
| <b>Weld-in Saddle With Male Thread</b><br><br>         | G28081 | 40x1/2"               |       |
|   | G28082 | 50x1/2"               |       |
|   | G28083 | 63x1/2"               |       |
|   | G28084 | 75x1/2"               |       |
|   | G28085 | 90x1/2"               |       |
|   | G28086 | 110x1/2"              |       |
|   | G28087 | 125x1/2"              |       |
|   | G28181 | 40x3/4"               |       |
|   | G28182 | 50x3/4"               |       |
|   | G28183 | 63x3/4"               |       |
|   | G28184 | 75x3/4"               |       |
|   | G28185 | 90x3/4"               |       |
|   | G28186 | 110x3/4"              |       |
|   | G28187 | 125x3/4"              |       |
| <b>Transition Round With Male Thread</b><br><br>     | G29101 | 20x1/2"               |       |
|   | G29102 | 20x3/4"               |       |
|   | G29103 | 25x1/2"               |       |
|   | G29104 | 25x3/4"               |       |
| <b>Transition Hexagon With Male Thread</b><br><br>   | G29204 | 32x1"                 |       |
|   | G29205 | 40x1 1/4"             |       |
|   | G29206 | 50x1 1/2"             |       |
|   | G29207 | 63x2"                 |       |
|   | G29208 | 75x2 1/2"             |       |
|   | G29209 | 90x3"                 |       |
|   | G29210 | 110x3"                |       |
|   | G29211 | 110x4"                |       |
| G29213  | 125x5" |                       |       |
| <b>Transition Hexagon With Female Thread</b><br><br> | G28204 | 32x1"                 |       |
|   | G28205 | 40x1 1/4"             |       |
|   | G28206 | 50x1 1/2"             |       |
|   | G28207 | 63x2"                 |       |
|   | G28208 | 75x2"                 |       |
|   | G28213 | 125x5"                |       |
| <b>Transition Tee With Female Thread</b><br><br>     | G29301 | 20x1/2"x20            |       |
|   | G29302 | 20x3/4"x20            |       |
|   | G29303 | 25x1/2"x25            |       |
|   | G29304 | 25x3/4"x25            |       |
|   | G29305 | 32x3/4"x32            |       |
|   | G29306 | 32x1"x32              |       |
| <b>Connector Elbow 90°</b><br><br>                   | G29020 | 20x1/2" IG<br>3/4" AG |       |
|   | G29021 | 25x1/2" IG<br>3/4" AG |       |
| <b>Connector Elbow 90° For Cavity Wall</b><br><br>   | G29030 | 20x1/2" IG<br>3/4" AG |       |





|  | CODE:   | SIZE (OD mm) | PRICE |
|--|---------|--------------|-------|
| <b>Wingback Elbow With Female Thread</b><br><br>  | G29002  | 20x1/2"      |       |
|  | G29003  | 20x3/4"      |       |
|  | G29004  | 25x1/2"      |       |
|  | G29005  | 25x3/4"      |       |
| <b>Loose Nut Female Union with Gasket</b><br><br><br><b>Designed to seal against flat face</b> | G29801  | 20x3/4"      |       |
|  | G29802  | 20x1"        |       |
|  | G29803  | 25x3/4"      |       |
|  | G29804  | 25x1"        |       |
|  | G29805  | 32x1"        |       |
|  | G29806  | 32x1 1/4"    |       |
|  | G29807  | 40x1 1/2"    |       |
|  | G29808  | 50x1 3/4"    |       |
|  | G29809  | 63x2 3/8"    |       |
|  | G29810  | 75x2 3/8"    |       |
| <b>Transition Round With Female Thread</b><br><br>  | G28101  | 20x1/2"      |       |
|  | G28102  | 20x3/4"      |       |
|  | G28103  | 25x1/2"      |       |
|  | G28104  | 25x3/4"      |       |
|  |         |              |       |
| <b>Transition Union Female Thread</b><br><br>  | G29601  | 20x1/2"      |       |
|  | G29602  | 20x3/4"      |       |
|  | G29603  | 25x1/2"      |       |
|  | G29604  | 25x3/4"      |       |
|  | G29605  | 32x1"        |       |
|  | G29606  | 32x3/4"      |       |
|  | G29607  | 40x1 1/4"    |       |
|  | G29608  | 50x1 1/2"    |       |
|  | G29609  | 63x2"        |       |
|  | G29610  | 75x2 1/2"    |       |
| <b>Transition Elbow With Female Thread</b><br><br>  | G28301  | 20x1/2"      |       |
|  | G28302  | 20x3/4"      |       |
|  | G28303  | 25x1/2"      |       |
|  | G28304  | 25x3/4"      |       |
|  | G28305  | 32x3/4"      |       |
|  | G28306  | 32x1"        |       |
| <b>Transition Elbow With Male Thread</b><br><br>  | G28401  | 20x1/2"      |       |
|  | G28402  | 20x3/4"      |       |
|  | G28403  | 25x1/2"      |       |
|  | G28404  | 25x3/4"      |       |
|  | G28405  | 32x3/4"      |       |
|  | G28406  | 32x1"        |       |
| <b>Transition Union Male Thread</b><br><br>  | G29701  | 20x1/2"      |       |
|  | G29702  | 20x3/4"      |       |
|  | G29703  | 25x1/2"      |       |
|  | G29704  | 25x3/4"      |       |
|  | G29705  | 32x1"        |       |
|  | G29706  | 32x3/4"      |       |
|  | G29707  | 40x1 1/4"    |       |
|  | G29708  | 50x1 1/2"    |       |
|  | G29709  | 63x2"        |       |
|  | G29710  | 75x2 1/2"    |       |
| <b>Crox Fitting</b><br><br>   | G29831  | 20x1/2"      |       |
| G29832   | 20x3/4" |              |       |
| G29833   | 25x3/4" |              |       |

### WEFATHERM VALVES

|  | CODE:  | SIZE (OD mm) | PRICE  |   | CODE:  | SIZE (OD mm) | PRICE |
|--|--------|--------------|--------|---|--------|--------------|-------|
| <b>Stop Valve With Surface Assembly</b><br><br>               | G29500 | 20           |        | <b>Ball Cock Valve</b><br><br>  | G25580 | 20           |       |
|  | G29501 | 25           |        |   | G25581 | 25           |       |
|  | G29502 | 32           |        |   | G25582 | 32           |       |
| <b>Stop Valve - Chromium Flush Mounted Assembly</b><br><br>   | G29510 | 20           |        | <b>For Hot &amp; Cold Water</b><br><br><b>Y Valve Without Discharge</b><br><br> | G29540 | 25           |       |
|  | G29511 | 25           |        |   | G29541 | 32           |       |
|  | G29512 | 32           |        |   | G29542 | 40           |       |
| <b>Stop Valve - Chromium Flush Mounted Assembly</b><br><br> | G29515 | 20           |        | <b>KFR Valve Without Discharge</b><br><br>                                      | G29550 | 25           |       |
|  | G29516 | 25           |        |   | G29551 | 32           |       |
|  |        |              |        |   | G29552 | 40           |       |
|  |        |              |        | <b>Outflow Connection For Y Valve</b><br><br>                                  | G29560 | 20           |       |
|  |        |              | G29561 |   | 25     |              |       |
|  |        |              | G29562 |   | 32     |              |       |
|  |        |              | G29563 |   | 40     |              |       |

Plastic Systems offer a wide range of valving to compliment this system.  
Please contact our sales team for recommendations and pricing

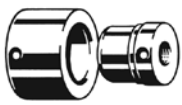
### TOOLING & ACCESSORIES

|  | CODE: | SIZE (OD mm) | PRICE |   | CODE:  | SIZE (OD mm) | PRICE |  |
|--|-------|--------------|-------|---|--|--------------|-------|--|
| <b>Repair Kit</b><br><br>                       | 30080 | 7            |       | <b>Drill</b><br><br>                        | 30070  | 25           |       |  |
|  | 30081 | 11           |       |   | <b>Chamfering Device</b><br><br> |              |       |  |
| <b>Welding Bush</b><br><br>                     | 30002 | 20           |       | <b>Peeling Tool For Stabi Pipes</b><br><br> |  | 34100        | 16+20 |  |
|  | 30003 | 25           |       |   |  | 34101        | 20+25 |  |
|  | 30004 | 32           |       |   |  | 34102        | 32+40 |  |
|  | 30005 | 40           |       |   |  | 34103        | 50+63 |  |
|  | 30006 | 50           |       |   |  | 34104        | 75    |  |
|  | 30007 | 63           |       |   |  | 34105        | 90    |  |
|  | 30008 | 75           |       |   |  | 34106        | 110   |  |
|  | 30009 | 90           |       |   |  | 34107        | 125   |  |
|  | 30010 | 110          |       |   |  |              |       |  |
| 30011  | 125   |              |       |   |  |              |       |  |
| <b>Welding Bush For Weld-in Saddles</b><br><br> | 30051 | 40           |       |   |  |              |       |  |
|  | 30052 | 50           |       |   |  |              |       |  |
|  | 30053 | 63           |       |   |  |              |       |  |
|  | 30054 | 75           |       |   |  |              |       |  |
|  | 30055 | 90           |       |   |  |              |       |  |
|  | 30056 | 110          |       |   |  |              |       |  |
| 30057  | 125   |              |       |   |  |              |       |  |

Refer to our Machines & Tooling catalogue for tools and welding equipment.

