

Chemical Waste System
Vulcathene Mechanical & Enfusion

Plastic Systems' Chemical Waste Systems continue to provide a comprehensive, corrosion resistant answer to severe industrial, trade and laboratory discharges.

This is a complete range of pipes and fittings in nominal sizes 40mm to 150mm with specialist accessories such as drip cups, antisiphons, dilution traps, sinks, etc.

Produced under ISO 9002 and QAS/48/4836/22 quality standards, Vulcathene holds BBA certification No 9/2805 for all its mechanical system, together with US NSF approvals and complies with AS/NZS 3500.2.2 with many above and below ground installations completed over the years.

Today **Plastic Systems** offers 3 compatible and interchangeable parts to the system.

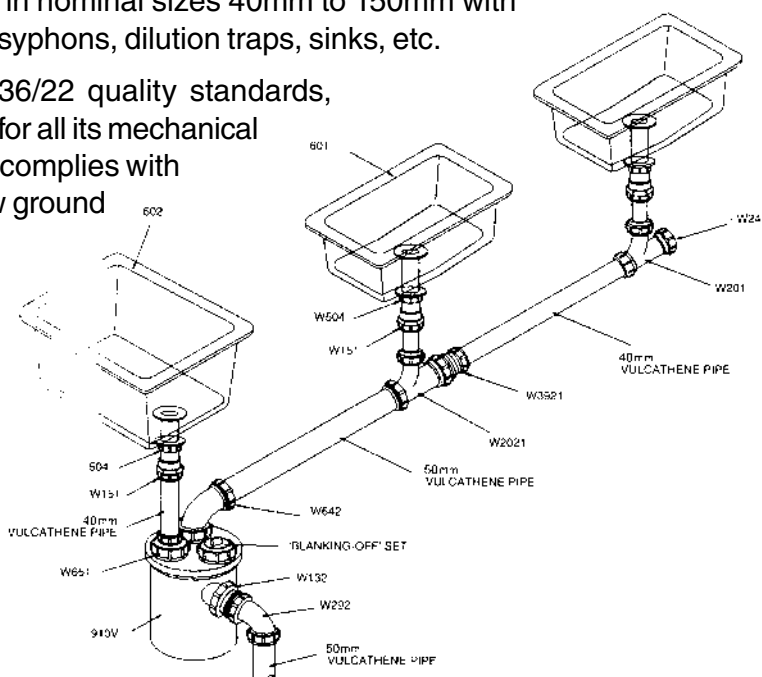

High Grade PP Chemical Waste Pipe

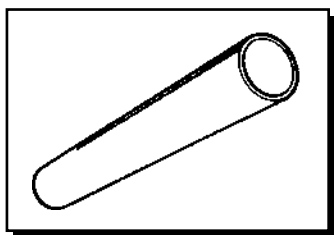

Vulcathene Mechanical Jointing System

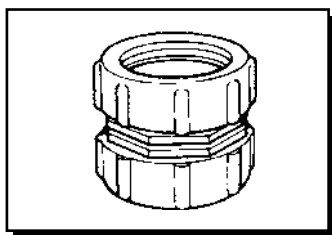

Enfusion Jointing System

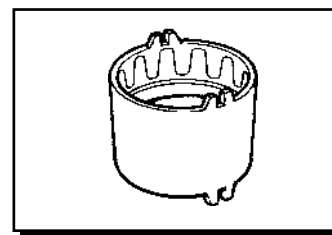

PP Chemical Waste Pipe

	PV Code	Size NB mm	Internal Diameter	External Diameter	Nom. Wall Thickness	Price per Metre
	W001 1	40	37.6	47.6	5.0	
	2	50	50.3	60.3	5	
	3	80	76	89	6.5	
	4	100	102.3	114.3	6	
	5	125	127.8	145.3	7	
	6	150	150.3	168.3	9	

PRICES INDICATED DO NOT INCLUDE GST



Asmuss Plastic Systems Limited

FREEPHONE: 0800 000 546 Facsimile: (64) (9) 477 - 2328

sales@plasticsystems.co.nz

34 Arrenway Drive, North Shore City 0632

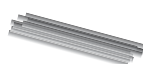

P.O. Box 100244, North Shore City 0745, Auckland, NZ





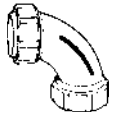
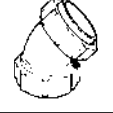

Pipe • Fittings • Valving • Measurement & Control

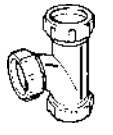
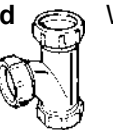
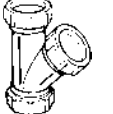
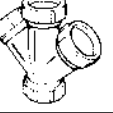
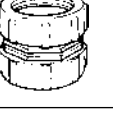
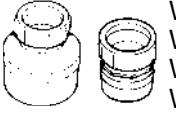
www.plasticsystems.co.nz

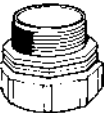
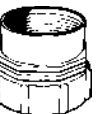
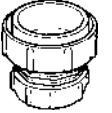
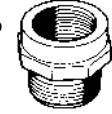
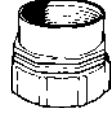
Vulcathene Mechanical Fitting System

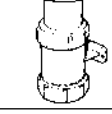
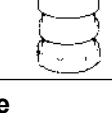
	<i>FV CODE</i>	Size (NB)	Price
92½° Bend 	W181	40	
	W182	50	
	W183	80	
	W184	100	
92½° Loose Nut Bend Bend 	W291	40	
	W292	50	
	W293	80	
	W294	100	
135° Loose Nut Bend 	W211	40	
	W212	50	
	W213	80	
	W214	100	
135° Bend 	W191	40	
	W192	50	
	W193	80	
	W194	100	
U Bend 	W701	40	
	W702	50	
92½° Equal Sweep Tee 	W201	40	
	W202	50	
	W203	80	
	W204	100	
92½° Reduced Branch Tee 	W2021	50 x 40	
45° Single Wye 	W371	40	
	W372	50	
	W373	80	
	W374	100	
45° Double Wye 	W381	40	
	W382	50	
	W383	80	
	W384	100	
Pipe Coupler 	W161	40	
	W162	50	
	W163	80	
	W164	100	
Reducing Coupler/Adaptor 	W3921	50x40	
	W3931	80x40	
	W3932	80x50	
	W3941	100x40	
	W3942	100x50	
	W3943	100x80	

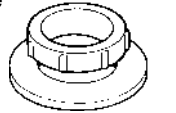
	<i>FV CODE</i>	Size (NB)	Price
MI to Pipe Coupler 	W141	40 x 1½"	
	W142	50 x 2"	
FI to Pipe Coupler 	W151	40	
	W152	50	
2½" FI to Pipe Coupler 	W132	50	
1¼" FI to 1½" MI BSP Reducer 	W121	40	
FI to Pipe Coupler 	W271	40 x 1¼"	
Beaded Glass Adaptor 	W451	40	
	W452	50	
	W453	80	
Thermal Stress Relief Unit 	W801	40	
	W802	50	
Thermal Stress Relief Unit 	W803	80	
	W804	100	
Access Pipe (Spigot Ends) 	W902	50	
	W903	80	
	W904	100	
BS Table D Flange 	WTD1	40	
	WTD2	50	
	WTD3	80	
	WTD4	100	



Vulcathene Traps, Wastes, Sinks & Accessories

P & S Traps can be easily configured from Fittings:



P Trap = 1 x U Bend + 1 x 92.5° Loose Nut Bend





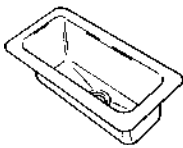

S Trap = 1 x U Bend + 2 x 92.5° Loose Nut Bends

	<i>FV CODE</i>	Size (NB)	Price
Dilution Recovery Trap  4.5 litre	W612	50	

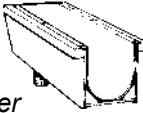
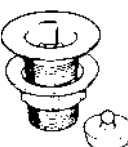

	<i>FV CODE</i>	Size (NB)	Price
Anti-Siphon Bottle Trap 	PP W561	40	
Glass Base 	W571	40	



Vulcathene Mechanical Traps, Wastes, Sinks & Accessories

	FV CODE	Size (NB)	Price
Anti-Syphon Dilution Recovery Trap 2.3 litre 	PP W681	40	
	Glass Base W691	40	
Clay Trap 	W915		
Circular Drip Cup Small 102mm dia. 	W501	40	
	Large 168mm dia. 	W500	40
Oval Drip Cup Small 175 x 102mm 	W497	40	
	Large 264 x 111mm 	W499B	40
	264 x 117mm	W499W	40
	305 x 152mm	W499T	40
Sink (Injection Moulded) 	W601S	40	
	W602	40	

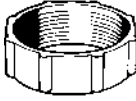



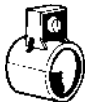



	FV CODE	Size (NB)	Price
Sink (Vacuum Formed) 	W6041	40	
	W6042	40	
	W6044	40	
<i>Order wastes separately</i>			
Trough 	W6051	40	
403 x 190mm			
Running Trough 	W603		
<i>Size to order</i>			
Wastes Unslotted or Slotted 	W504	32x63	
	W504S	40x63 40x89 50x89	
Plug & Chain Assemblies 	W5081	32	
	W5082	40	
	W5083	50	
Overflow Assemblies 	W509		
	<i>(waste is not included)</i>		
Standing Waste Tubes Plain 	W5071	32x140	
	W5073	32x180	
	W5075	40x140	
	W5077	40x180	
	W5079	50x225	



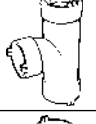

Vulcathene Accessories

	FV CODE	Size (NB)	Price
No Heat Olive 	W2211	40	
	W2221	50	
	W2231	80	
	W2241	100	
Nut 	W231	40	
	W232	50	
	W233	80	
	W234	100	
Blanking-Off Plug 	W241	40	
	W242	50	
	W243	80	
	W244	100	

	FV CODE	Size (NB)	Price
Spanner 	W36	1 40	
		2 50	
		3 80	
		4 100	
Cutting Tool 	W26	1 40	
		2 50	
		3 80	
		4 100	
Vulcathene Lubricant 	WLP		

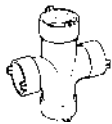
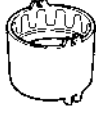
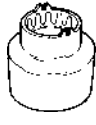

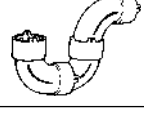
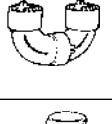
Vulcathene Enfusion Fitting System

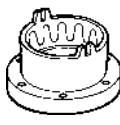
	FV CODE	Size (NB)	Price
Long Sweep Bend M & F 	L281	40	
	L282	50	
	L283	80	
	L284	100	
	L286	150	
Socketed Long Sweep Bend 	L171	40	
	L172	50	
	L173	80	
	L174	100	
	L176	150	
Socket Short Sweep Bend 	L181	40	
	L182	50	
Socketed 45° Bend 	L191	40	
	L192	50	
	L193	80	
	L194	100	
Socket/Spigot 45° Slow Bend 	L211	40	
	L212	50	
	L213	80	
	L214	100	
92½° Equal Sweep Tee Socketed 	L201	40	
	L202	50	
	L203	80	
	L204	100	
92½° Reducing Sweep Tee Socketed 	L2031	80x40	
	L2032	80x50	
45° Single Wye (Socketed) 	L371	40	
	L372	50	
	L373	80	
	L374	100	
	L376	150	
45° Reducing Wye (Socketed) 	L3721	50x40	
	L3731	80x40	
	L3732	80x50	
	L3742	100x50	
	L3743	100x80	
	L3762	150x50	
	L3763	150x80	
L3764	150x100		

	FV CODE	Size (NB)	Price
92½° Double Branch (Socketed) 	L351	40	
	L352	50	
	L353	80	
	L354	100	
Coupler (Socketed) 	L161	40	
	L162	50	
	L163	80	
	L164	100	
	L166	150	
Reducing Coupler (Socketed/Spigot) 	L3912	50x40	
	L3913	80x40	
	L3914	100x40	
	L3916	150x40	
	L3923	80x50	
	L3924	100x50	
	L3926	150x50	
	L3934	100x80	
	L3936	150x80	
L3946	150x100		
FI to Pipe Coupler 	L151	40	
	L152	50	
'P' Trap (Socketed) 	LT13	80	
	LT14	100	
	LT16	150	
U Bend (Socketed) 	L1011	40	
	L1012	50	
Access Pipe 	L902	50	
	L903	80	
	L904	100	
Flange 	L361	40	
	L362	50	
	L363	80	
	L364	100	
	L366	150	
<i>N.B.: Bolts supplied separately. Also available undrilled</i>			

Enfusion Accessories

	FV CODE	Size (NB)	Price
Cleanout Plug 	L24 1	40	
	2	50	
	3	80	
	4	100	
	6	150	
Enfusion Control Box	L2600		
	L2601		

	FV CODE	Size (NB)	Price
Pipe Scraper 	PFS3002001		
Clamps (Socketed) 	L261	40	
	L262	50	
	L263	80	
	L264	100	
	L266	150	
Link Cable 	L2610		