

## Chemical Waste System

### Vulcathene Mechanical & Enfusion

**Asmuss Group's Chemical Waste Systems** continue to provide a comprehensive, corrosion resistant answer to severe industrial, trade and laboratory discharges.

This is a complete range of pipes and fittings in nominal sizes 40mm to 150mm with specialist accessories such as drip cups, antisiphons, dilution traps, sinks, etc.

Produced under ISO 9002 and QAS/48/4836/22 quality standards, Vulcathene holds BBA certification No 9/2805 for all its mechanical system, together with US NSF approvals and complies with AS/NZS 3500.2.2 with many above and below ground installations completed over the years.

Today **Asmuss Group** offers 3 compatible and interchangeable parts to the system.

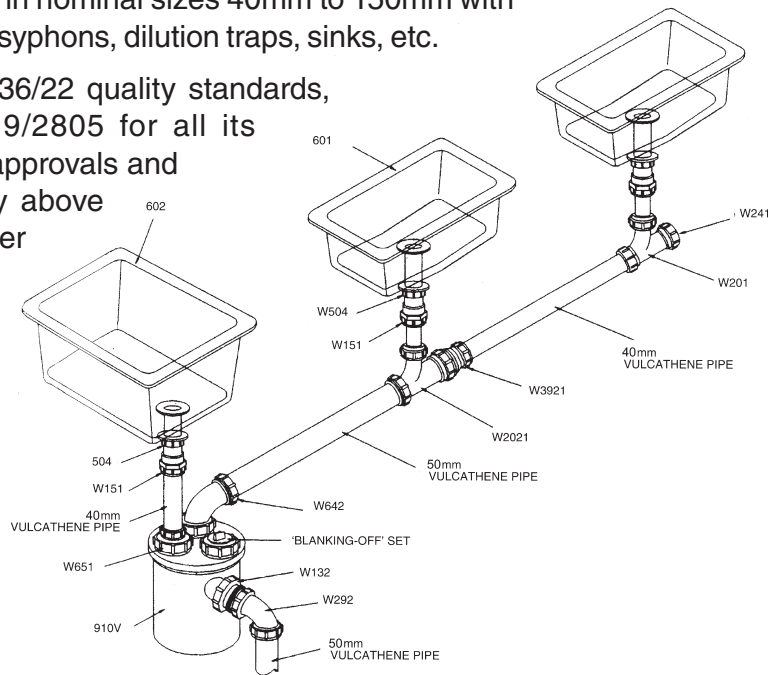

#### High Grade PP Chemical Waste Pipe

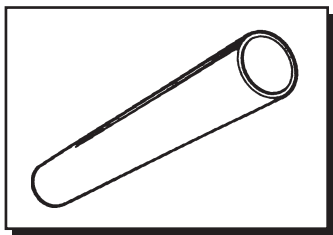

#### Vulcathene Mechanical Joining System

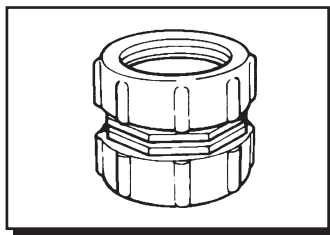

#### Enfusion Joining System

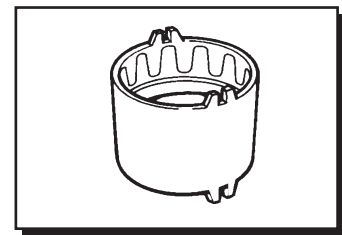

### PP Chemical Waste Pipe

	PV Code	Size NB mm	Internal Diameter	External Diameter	Nom. Wall Thickness	Price per Metre
Pipe 	W001 1	40	37.6	47.6	5.0	
	2	50	50.3	60.3	5	
	3	80	76	89	6.5	
	4	100	102.3	114.3	6	
	5	125	127.8	145.3	7	
	6	150	150.3	168.3	9	

PRICES INDICATED DO NOT INCLUDE GST



## Vulcathene Mechanical Fitting System

	FV CODE	Size (NB)	Price
92½° Bend	W181	40	
	W182	50	
	W183	80	
	W184	100	
92½° Loose Nut Bend Bend	W291	40	
	W292	50	
	W293	80	
	W294	100	
135° Loose Nut Bend	W211	40	
	W212	50	
	W213	80	
	W214	100	
135° Bend	W191	40	
	W192	50	
	W193	80	
	W194	100	
U Bend	W701	40	
	W702	50	
92½° Equal Sweep Tee	W201	40	
	W202	50	
	W203	80	
	W204	100	
92½° Reduced Branch Tee	W2021	50 x 40	
45° Single Wye	W371	40	
	W372	50	
	W373	80	
	W374	100	
45° Double Wye	W381	40	
	W382	50	
	W383	80	
	W384	100	
Pipe Coupler	W161	40	
	W162	50	
	W163	80	
	W164	100	
Reducing Coupler/Adaptor	W3921	50x40	
	W3931	80x40	
	W3932	80x50	
	W3941	100x40	
	W3942	100x50	
	W3943	100x80	

	FV CODE	Size (NB)	Price
MI to Pipe Coupler	W141	40 x 1½"	
	W142	50 x 2"	
FI to Pipe Coupler	W151	40	
	W152	50	
2½" FI to Pipe Coupler	W132	50	
1¼" FI to 1½" MI BSP Reducer	W121	40	
FI to Pipe Coupler	W271	40 x 1¼"	
Beaded Glass Adaptor	W451	40	
	W452	50	
	W453	80	
Thermal Stress Relief Unit	W801	40	
	W802	50	
Thermal Stress Relief Unit	W803	80	
	W804	100	
Access Pipe (Spigot Ends)	W902	50	
	W903	80	
	W904	100	
BS Table D Flange	WTD1	40	
	WTD2	50	
	WTD3	80	
	WTD4	100	

## Vulcathene Traps, Wastes, Sinks & Accessories

P & S Traps can be easily configured from Fittings:

P Trap = 1 x U Bend + 1 x 92.5° Loose Nut Bend

S Trap = 1 x U Bend + 2 x 92.5° Loose Nut Bends





	FV CODE	Size (NB)	Price
Dilution Recovery Trap 4.5 litre	W612	50	

	FV CODE	Size (NB)	Price
Anti-Siphon Bottle Trap	PP W561	40	
	Glass Base W571	40	





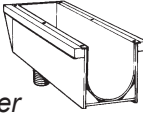
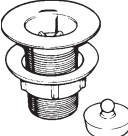

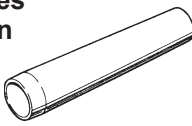
## Vulcathene Mechanical Traps, Wastes, Sinks & Accessories

	FV CODE	Size (NB)	Price
<b>Anti-Syphon Dilution Recovery Trap</b> 2.3 litre 	<b>PP</b> W681	40	
<b>Glass Base</b> 	W691	40	
<b>Clay Trap</b> 	W915		
<b>Circular Drip Cup Small</b> 102mm dia. 	W501	40	
<b>Large</b> 168mm dia. 	W500	40	
<b>Oval Drip Cup Small</b> 175 x 102mm 	W497	40	
<b>Large</b> 264 x 111mm 264 x 117mm 305 x 152mm 	W499B W499W W499T	40 40 40	
<b>Sink (Injection Moulded)</b> 			
496 x 214 x 171mm 552 x 400 x 238mm	W601S W602	40 40	

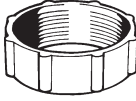
	FV CODE	Size (NB)	Price
<b>Sink (Vacuum Formed)</b> 	W6041 W6042 W6044	40 40 40	
<i>Order wastes separately</i>			
<b>Trough</b> 	W6051	40	
403 x 190mm			
<b>Running Trough</b> 	W603		
<i>Size to order</i>			
<b>Wastes Unslotted or Slotted</b> 	W504 W504S	32x63 40x63 40x89 50x89	
<b>Plug &amp; Chain Assemblies</b> 	W5081 W5082 W5083	32 40 50	
<b>Overflow Assemblies</b> 	W509		
<i>(waste is not included)</i>			
<b>Standing Waste Tubes Plain</b> 	W5071 W5073 W5075 W5077 W5079	32x140 32x180 40x140 40x180 50x225	







## Vulcathene Accessories

	FV CODE	Size (NB)	Price
<b>No Heat Olive</b> 	W2211 W2221 W2231 W2241	40 50 80 100	
<b>Nut</b> 	W231 W232 W233 W234	40 50 80 100	
<b>Blanking-Off Plug</b> 	W241 W242 W243 W244	40 50 80 100	

	FV CODE	Size (NB)	Price
<b>Spanner</b> 	W36 1 2 3 4	40 50 80 100	
<b>Cutting Tool</b> 	W26 1 2 3 4	40 50 80 100	
<b>Vulcathene Lubricant</b> 	WLP		



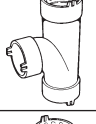
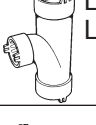

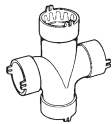
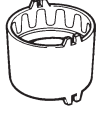
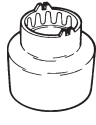
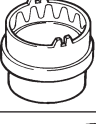
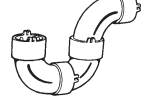
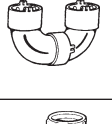
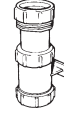
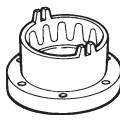

## Vulcathene Enfusion Fitting System

	FV CODE	Size (NB)	Price
Long Sweep Bend M & F 	L281	40	
	L282	50	
	L283	80	
	L284	100	
	L286	150	
Socketed Long Sweep Bend 	L171	40	
	L172	50	
	L173	80	
	L174	100	
	L176	150	
Socket Short Sweep Bend 	L181	40	
	L182	50	
Socketed 45° Bend 	L191	40	
	L192	50	
	L193	80	
	L194	100	
Socket/Spigot 45° Slow Bend 	L211	40	
	L212	50	
	L213	80	
	L214	100	
92½° Equal Sweep Tee Socketed 	L201	40	
	L202	50	
	L203	80	
	L204	100	
92½° Reducing Sweep Tee Socketed 	L2031	80x40	
	L2032	80x50	
45° Single Wye (Socketed) 	L371	40	
	L372	50	
	L373	80	
	L374	100	
	L376	150	
45° Reducing Wye (Socketed) 	L3721	50x40	
	L3731	80x40	
	L3732	80x50	
	L3742	100x50	
	L3743	100x80	
	L3762	150x50	
	L3763	150x80	
L3764	150x100		

	FV CODE	Size (NB)	Price
92½° Double Branch (Socketed) 	L351	40	
	L352	50	
	L353	80	
	L354	100	
Coupler (Socketed) 	L161	40	
	L162	50	
	L163	80	
	L164	100	
	L166	150	
Reducing Coupler (Socketed/Spigot) 	L3912	50x40	
	L3913	80x40	
	L3914	100x40	
	L3916	150x40	
	L3923	80x50	
	L3924	100x50	
	L3926	150x50	
	L3934	100x80	
L3936	150x80		
L3946	150x100		
FI to Pipe Coupler 	L151	40	
	L152	50	
'P' Trap (Socketed) 	LT13	80	
	LT14	100	
	LT16	150	
U Bend (Socketed) 	L1011	40	
	L1012	50	
Access Pipe 	L902	50	
	L903	80	
	L904	100	
Flange 	L361	40	
	L362	50	
	L363	80	
	L364	100	
	L366	150	
<i>N.B.: Bolts supplied separately. Also available undrilled</i>			

## Enfusion Accessories

	FV CODE	Size (NB)	Price
Cleanout Plug 	L24 1	40	
	2	50	
	3	80	
	4	100	
	6	150	
Enfusion Control Box	L2600		
	L2601		

	FV CODE	Size (NB)	Price
Pipe Scraper 	PFS3002001		
Clamps (Socketed) 	L261	40	
	L262	50	
	L263	80	
	L264	100	
	L266	150	
Link Cable 	L2610		