

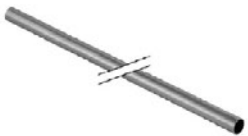



■ GEBERIT MAPRESS 316 Stainless Steel Crimped Piping System



316 ST. STEEL PIPE

	CODE:	SIZE (OD) mm	PRICE
 6 Metre Lengths	Pipe	39202	15
		39204	22
		39205	28
		39206	35
		39207	42
		39208	54
		39209	76.1
		39210	88.9
		39211	108





316 ST. STEEL COUPLINGS

	CODE:	SIZE (OD)	PRICE
	Coupling	32002	15
		32004	22
		32005	28
		32006	35
		32007	42
		32008	54
		32009	76.1
		32010	88.9
		32011	108
		Slip Coupling	32102
		32104	22
		32105	28
		32106	35
		32107	42
		32108	54
		32109	76.1
		32110	88.9
		32111	108

316 ST. STEEL PLAIN END BENDS

	CODE:	SIZE (OD) mm	PRICE
	45° Bend With Plain End	30702	15
		30704	22
		30705	28
		32706	35
		32707	42
		32708	54
		32709	76.1
		32710	88.9
		32711	108
		90° Bend With Plain End	30302
		30304	22
		30305	28
		33306	35
		33307	42
		33308	54
		33309	76.1
		33310	88.9
		33311	108

316 ST. STEEL BENDS



	CODE:	SIZE (OD) mm	PRICE
	Bend 15°	36101	15
		36103	22
		36104	28
		36105	35
		36106	42
		36107	54
		36108	76.1
		36109	88.9
		36110	108
		Bend 30°	36121
		36123	22
		36124	28
		36125	35
		36126	42
		36127	54
		36128	76.1
		36129	88.9
		36130	108
		Bend 45°	30601
		30602	15
		30604	22
		30605	28
		32606	35
		32607	42
		32608	54
		32609	76.1
		32610	88.9
		32611	108
	Bend 60°	36161	15
		36163	22
		36164	28
		36165	35
		36166	42
		36167	54
		36168	76.1
		36169	88.9
		36170	108
		Bend 90°	30102
		30104	22
		30105	28
		31106	35
		31107	42
		31108	54
		31109	76.1
		31110	88.9
		31111	108

PRICES INDICATED DO NOT INCLUDE GST





316 ST. STEEL ELBOWS

	CODE:	SIZE (OD) mm	PRICE
90° Elbow Adaptor With Female Thread 	33803	15 x Rp ½"	
	33802	15 x Rp ⅜"	
	33805	22 x Rp ¾"	
	33806	28 x Rp 1"	
	33807	35 x Rp 1¼"	
90° Elbow Adaptor With Female Thread And Plain End 	33203	15 x Rp ½"	

	CODE:	SIZE (OD) mm	PRICE
90° Elbow Adaptor With Male Thread 	33833	15 x R ½"	
	33835	22 x R ¾"	
	33836	28 x R 1"	
	33837	35 x R 1¼"	
	33838	42 x R 1½"	
	33839	54 x R 2"	
90° Elbow Tap Connector 	33013 33403 33407	12 x Rp ½" x L430 15 x Rp ½" x L430 22 x Rp ¾" x L510	

316 ST. STEEL TEES

	CODE:	SIZE (OD) mm	PRICE	
Equal Tee 	31002	15		
	31004	22		
	31005	28		
	31006	35		
	31007	42		
	31008	54		
	31009	76.1		
	31010	88.9		
	31011	108		
90° Offset Tee Elbow Tap Connector 	33423	15 x Rp ½" x L650		
	33427	22 x Rp ¾" x L650		
Tee With Female Thread 	31304	15 x Rp ½" x 15		
	31307	22 x Rp ½" x 22		
	31308	22 x Rp ¾" x 22		
	31311	28 x Rp 1" x 28		
	31309	28 x Rp ½" x 28		
	31310	28 x Rp ¾" x 28		
	31312	35 x Rp ½" x 35		
	31313	35 x Rp ¾" x 35		
	31316	42 x Rp ½" x 42		
	31317	42 x Rp ¾" x 42		
	31320	54 x Rp ½" x 54		
	31324	54 x Rp 2" x 54		
	31321	54 x Rp ¾" x 54		
	31329	76.1 x Rp 2" x 76.1		
	31326	76.1 x Rp ¾" x 76.1		
	31334	88.9 x Rp 2" x 88.9		
	31331	88.9 x Rp ¾" x 88.9		
	31339	108 x Rp 2" x 108		
31336	108 x Rp ¾" x 108			
Tee With Female Thread 	31454	15 x Rp ½" x 15		
	31401	15 x Rp ⅜" x 15		
	31458	22 x Rp ¾" x 22		
	31461	28 x Rp 1" x 28		
	31464	35 x Rp ¼" x 35		

	CODE:	SIZE (OD) mm	PRICE
Reducing Tee 	33005	15 x 12 x 15	
	31227	22 x 15 x 18	
	31206	22 x 15 x 22	
	31234	28 x 22 x 22	
	31211	28 x 22 x 28	
	31212	35 x 15 x 35	
	31235	35 x 22 x 28	
	31214	35 x 22 x 35	
	31242	35 x 28 x 28	
	31215	35 x 28 x 35	
	31216	42 x 15 x 42	
	31243	42 x 22 x 35	
	31218	42 x 22 x 42	
	31251	42 x 28 x 35	
	31219	42 x 28 x 42	
	31220	42 x 35 x 42	
	31221	54 x 15 x 54	
	31223	54 x 22 x 54	
	31224	54 x 28 x 54	
	31225	54 x 35 x 54	
	31226	54 x 42 x 54	
	31229	76.1 x 22 x 76.1	
	31230	76.1 x 28 x 76.1	
	31231	76.1 x 35 x 76.1	
	31232	76.1 x 42 x 76.1	
	31233	76.1 x 54 x 76.1	
	31236	88.9 x 22 x 88.9	
	31237	88.9 x 28 x 88.9	
	31238	88.9 x 35 x 88.9	
	31239	88.9 x 42 x 88.9	
31240	88.9 x 54 x 88.9		
31241	88.9 x 76.1 x 88.9		
31244	108 x 22 x 108		
31245	108 x 28 x 108		
31246	108 x 35 x 108		
31247	108 x 42 x 108		
31248	108 x 54 x 108		
31249	108 x 76.1 x 108		
31250	108 x 88.9 x 108		



316 ST. STEEL REDUCERS

	CODE:	SIZE (OD)	PRICE
	33002	15 x 12	
	32305	22 x 15	
	32307	28 x 15	
	32309	28 x 22	
	32310	35 x 15	
	32312	35 x 22	
	32313	35 x 28	
	32314	42 x 15	
	32316	42 x 22	
	32317	42 x 28	
	32318	42 x 35	
	32319	54 x 15	
	32321	54 x 22	
	32322	54 x 28	
	32323	54 x 35	
	32324	54 x 42	
	32331	76.1 x 54	
	32338	88.9 x 54	
	32339	88.9 x 76.1	
	32345	108 x 54	
32346	108 x 76.1		
32348	108 x 88.9		

316 ST. STEEL UNIONS

	CODE:	SIZE (OD) mm	PRICE
	35390	15 x G 3/4"	
	35392	22 x G 1"	
	35393	28 x G 1 1/4"	
	35394	35 x G 1 1/2"	
	35395	42 x G 1 3/4"	
	35396	54 x G 2 3/8"	
	Union nut made of CRNI steel		

316 ST. STEEL ADAPTOR UNIONS

	CODE:	SIZE (OD) mm	PRICE	
	35350	15 x Rp 1/2" x G 3/4"		
	35357	15 x Rp 3/4" x G 3/4"		
	35359	22 x Rp 1" x G 1"		
	35352	22 x Rp 3/4" x G 1"		
	35353	28 x Rp 1" x G 1 1/4"		
	35354	35 x Rp 1 1/4" x G 1 1/2"		
	35355	42 x Rp 1 1/2" x G 1 3/4"		
	35356	54 x Rp 2" x G 2 3/8"		
	Union nut made of CRNI steel			
		35360	15 x R 1/2" x G 3/4"	
35361		15 x R 3/4" x G 3/4"		
35366		22 x R 1" x G 1"		
35364		22 x R 1/2" x G 1"		
35365		22 x R 3/4" x G 1"		
35367		28 x R 1" x G 1 1/4"		
35368		35 x R 1 1/4" x G 1 1/2"		
35369		42 x R 1 1/2" x G 1 3/4"		
35370		54 x R 2" x G 2 3/8"		
Union nut made of CRNI steel				





316 ST. STEEL END CAPS

	CODE:	SIZE (OD)	PRICE
	33212	15	
	33214	22	
	33215	28	
	33216	35	
	33217	42	
	33218	54	
	33219	76.1	
	33220	88.9	
	33221	108	

316 ST. STEEL EXPANSION FITTINGS

	CODE:	SIZE (OD) mm	PRICE
	33935	28 x 39	
	33936	35 x 46	
	33937	42 x 56	
	33938	54 x 70	
	33939	76.1 x 88	
	33940	88.9 x 117	
	33941	108 x 144	



316 ST. STEEL ADAPTORS

	CODE:	SIZE (OD)	PRICE
	31802	15 x Rp 1/2"	
	31823	15 x Rp 3/4"	
	31801	15 x Rp 3/8"	
	31824	22 x Rp 1"	
	31805	22 x Rp 1/2"	
	31806	22 x Rp 3/4"	
	31825	28 x Rp 1 1/4"	
	31809	28 x Rp 1"	
	31807	28 x Rp 1/2"	
	31819	28 x Rp 3/4"	
	31826	35 x Rp 1 1/2"	
	31811	35 x Rp 1 1/4"	
	31820	35 x Rp 1"	
	31814	42 x Rp 1 1/2"	
	31821	42 x Rp 1 1/4"	
	31822	54 x Rp 1 1/2"	
	31818	54 x Rp 2"	
	31932	15 x R 1/2"	
	31936	22 x R 3/4"	
	31937	28 x R 1"	
	31938	35 x R 1 1/4"	
	31939	42 x R 1 1/2"	
	31940	54 x R 2"	
	Adaptor Male Thread, NPT		
	31833	15 x R 1/2"	
	31837	22 x R 3/4"	
	31838	28 x R 1"	
	31839	35 x R 1 1/4"	
	31840	42 x R 1 1/2"	
	31841	54 x R 2"	
	31703	15 x R 1/2"	
	31714	15 x R 3/4"	
	31726	15 x R 3/8"	
	31716	22 x R 1"	
	31715	22 x R 1/2"	
	31707	22 x R 3/4"	
	31718	28 x R 1 1/4"	
	31708	28 x R 1"	
	31717	28 x R 3/4"	
	31720	35 x R 1 1/2"	
	31709	35 x R 1 1/4"	
	31719	35 x R 1"	
	31710	42 x R 1 1/2"	
	31721	42 x R 1 1/4"	
	31722	54 x R 1 1/2"	
31711	54 x R 2"		
31713	76.1 x R 2 1/2"		
31724	88.9 x R 3"		
	35132	15 x G 3/4"	
	35134	22 x G 1"	
	35075	28 x G 1 1/2"	









316 ST. STEEL FLANGES

	CODE:	SIZE (OD) mm	PRICE
Flange PN 10/16 Plain End 	33748	54	
	33749	76.1	
	33750	88.9	
	33752	108	
Flange PN 10/16 With Pressing Socket 	33732	15	
	33734	22	
	33735	28	
	33736	35	
	33737	42	
	33738	54	
	33739	76.1	
	33740	88.9	
	33741	108	
Flanged Stub With Plain End For Loose Flange PN 10/16 	36141	22	
	36142	28	
	36143	35	
	36144	42	
	36145	54	
	36146	76.1	
	36147	88.9	
	36148	108	
Seal Ring CIIR, Black 	90402	15	
	90404	22	
	90405	28	
	90406	35	
	90407	42	
	90408	54	
	90409	76.1	
	90410	88.9	
	90411	108	
Seal Ring FKM, Blue 	90881	12	
	90882	15	
	90884	22	
	90885	28	
	90886	35	
	90887	42	
	90888	54	
	90891	76.1	
	90893	108	

316 ST. STEEL VALVES

	CODE:	SIZE (OD) mm	PRICE
316 SS Ball Valve With Lever Handle CIIR/PTFE 	92100	15	
	92102	22	
	92103	28	
	92104	35	
	92105	42	
	92106	54	
	92107	76.1	
	92108	88.9	
	92109	108	
316 SS Non-Return Valve CIIR/PTFE 	92140	15	
	92142	22	
	92143	28	
	92144	35	
	92145	42	
	92146	54	
	92147	76.1	
	92148	88.9	
	92149	108	

MAPRESS ST. STEEL TOOLING

	CODE:	PRICE
Mapress Starter Kit Suitable For D15-35mm incl: ACO 203 pressing tool, jaws, battery, charger, deburrer and marking tools 	MPRESSKIT	
Pressing Tool, In Case 	ACO 203 (2), AS/NZS 3112 691.218.P6.1 ACO 203XL (2XL), AS/NZS 3112 691.228.P6.1	
Li-Ion Battery, 18V	690.599.00.1	
Battery Charger 18V, AS/NZS 3112	690.598.P6.1	
Brunox Turbo-Spray	90000	
	CODE:	SIZE (OD) mm
Pressing Jaw (2) 	90532 90534 90535 90536	15 22 28 35
Pressing Collar Set (2), In Case	691.296.00.2	42-54
Pressing Collar Set (2XL), In Case	691.188.00.1	76.1/88.9
Pressing Collar Set (2XL), In Case	691.189.00.1	108
Adaptor Jaw (2XL) Adaptor Jaw ZB222 (2XL)	691.186.00.1 691.187.00.1	76.1/88.9 & 108 108
Case For Pressing Jaw (2),(3) 	691.137.00.1	
Insertion Distance Template With Marker Pen	90351	12 - 108
Marker Pen 	90358	
Pipe Deburrer 	90363	12 - 54
Pressure Test Plug 	90922 90924 90925 90926 90927 90928 90929 90930 90931	15 22 28 35 42 54 76.1 88.9 108
Pipe Cutter 	91088	12 - 54
Set Of Cutting Wheels For Pipe Cutter	91092	12 - 54