

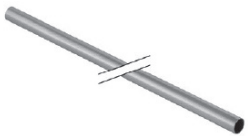

■ GEBERIT MAPRESS

316 Stainless Steel Crimped Piping System



316 ST. STEEL PIPE

	CODE:	SIZE (OD) mm	PRICE
 6 Metre Lengths	M39202	15	
	M39204	22	
	M39205	28	
	M39206	35	
	M39207	42	
	M39208	54	
	M39209	76.1	
	M39210	88.9	
	M39211	108	





316 ST. STEEL COUPLINGS

	CODE:	SIZE (OD)	PRICE
 Coupling	M32002	15	
	M32004	22	
	M32005	28	
	M32006	35	
	M32007	42	
	M32008	54	
	M32009	76.1	
	M32010	88.9	
	M32011	108	
	 Slip Coupling	M32102	15
M32104		22	
M32105		28	
M32106		35	
M32107		42	
M32108		54	
M32109		76.1	
M32110		88.9	
M32111		108	

316 ST. STEEL PLAIN END BENDS

	CODE:	SIZE (OD) mm	PRICE
 45° Bend With Plain End	M30702	15	
	M30704	22	
	M30705	28	
	M32706	35	
	M32707	42	
	M32708	54	
	M32709	76.1	
	M32710	88.9	
	M32711	108	
	 90° Bend With Plain End	M30302	15
M30304		22	
M30305		28	
M33306		35	
M33307		42	
M33308		54	
M33309		76.1	
M33310		88.9	
M33311		108	

316 ST. STEEL BENDS

	CODE:	SIZE (OD) mm	PRICE
 Bend 15°	M36101	15	
	M36103	22	
	M36104	28	
	M36105	35	
	M36106	42	
	M36107	54	
	M36108	76.1	
	M36109	88.9	
	M36110	108	
	 Bend 30°	M36121	15
M36123		22	
M36124		28	
M36125		35	
M36126		42	
M36127		54	
M36128		76.1	
M36129		88.9	
M36130		108	
 Bend 45°		M30601	12
	M30602	15	
	M30604	22	
	M30605	28	
	M32606	35	
	M32607	42	
	M32608	54	
	M32609	76.1	
	M32610	88.9	
	M32611	108	
 Bend 60°	M36161	15	
	M36163	22	
	M36164	28	
	M36165	35	
	M36166	42	
	M36167	54	
	M36168	76.1	
	M36169	88.9	
	M36170	108	
	 Bend 90°	M30102	15
M30104		22	
M30105		28	
M31106		35	
M31107		42	
M31108		54	
M31109		76.1	
M31110		88.9	
M31111		108	

PRICES INDICATED DO NOT INCLUDE GST





■ GEBERIT MAPRESS



316 Stainless Steel Crimped Piping System

316 ST. STEEL ELBOWS

	CODE:	SIZE (OD) mm	PRICE
90° Elbow Adaptor With Female Thread 	M33803	15 x Rp ½"	
	M33802	15 x Rp ¾"	
	M33805	22 x Rp ¾"	
	M33806	28 x Rp 1"	
	M33807	35 x Rp 1¼"	
90° Elbow Adaptor With Female Thread And Plain End 	M33203	15 x Rp ½"	

	CODE:	SIZE (OD) mm	PRICE
90° Elbow Adaptor With Male Thread 	M33833	15 x R ½"	
	M33835	22 x R ¾"	
	M33836	28 x R 1"	
	M33837	35 x R 1¼"	
	M33838	42 x R 1½"	
	M33839	54 x R 2"	
90° Elbow Tap Connector 	M33013 M33403 M33407	12 x Rp ½" x L430 15 x Rp ½" x L430 22 x Rp ¾" x L510	

316 ST. STEEL TEES

	CODE:	SIZE (OD) mm	PRICE
Equal Tee 	M31002	15	
	M31004	22	
	M31005	28	
	M31006	35	
	M31007	42	
	M31008	54	
	M31009	76.1	
	M31010	88.9	
	M31011	108	
	90° Offset Tee Elbow Tap Connector 	M33423	15 x Rp ½" x L650
M33427		22 x Rp ¾" x L650	
Tee With Female Thread 	M31304	15 x Rp ½" x 15	
	M31307	22 x Rp ½" x 22	
	M31308	22 x Rp ¾" x 22	
	M31311	28 x Rp 1" x 28	
	M31309	28 x Rp ½" x 28	
	M31310	28 x Rp ¾" x 28	
	M31312	35 x Rp ½" x 35	
	M31313	35 x Rp ¾" x 35	
	M31316	42 x Rp ½" x 42	
	M31317	42 x Rp ¾" x 42	
	M31320	54 x Rp ½" x 54	
	M31324	54 x Rp 2" x 54	
	M31321	54 x Rp ¾" x 54	
	M31329	76.1 x Rp 2" x 76.1	
	M31326	76.1 x Rp ¾" x 76.1	
	M31334	88.9 x Rp 2" x 88.9	
	M31331	88.9 x Rp ¾" x 88.9	
	M31339	108 x Rp 2" x 108	
M31336	108 x Rp ¾" x 108		
Tee With Male Thread 	M31454	15 x Rp ½" x 15	
	M31401	15 x Rp ¾" x 15	
	M31458	22 x Rp ¾" x 22	
	M31461	28 x Rp 1" x 28	
	M31464	35 x Rp ¼" x 35	

	CODE:	SIZE (OD) mm	PRICE
Reducing Tee 	M33005	15 x 12 x 15	
	M31227	22 x 15 x 18	
	M31206	22 x 15 x 22	
	M31234	28 x 22 x 22	
	M31211	28 x 22 x 28	
	M31212	35 x 15 x 35	
	M31235	35 x 22 x 28	
	M31214	35 x 22 x 35	
	M31242	35 x 28 x 28	
	M31215	35 x 28 x 35	
	M31216	42 x 15 x 42	
	M31243	42 x 22 x 35	
	M31218	42 x 22 x 42	
	M31251	42 x 28 x 35	
	M31219	42 x 28 x 42	
	M31220	42 x 35 x 42	
	M31221	54 x 15 x 54	
	M31223	54 x 22 x 54	
	M31224	54 x 28 x 54	
	M31225	54 x 35 x 54	
	M31226	54 x 42 x 54	
	M31229	76.1 x 22 x 76.1	
	M31230	76.1 x 28 x 76.1	
	M31231	76.1 x 35 x 76.1	
	M31232	76.1 x 42 x 76.1	
	M31233	76.1 x 54 x 76.1	
	M31236	88.9 x 22 x 88.9	
M31237	88.9 x 28 x 88.9		
M31238	88.9 x 35 x 88.9		
M31239	88.9 x 42 x 88.9		
M31240	88.9 x 54 x 88.9		
M31241	88.9 x 76.1 x 88.9		
M31244	108 x 22 x 108		
M31245	108 x 28 x 108		
M31246	108 x 35 x 108		
M31247	108 x 42 x 108		
M31248	108 x 54 x 108		
M31249	108 x 76.1 x 108		
M31250	108 x 88.9 x 108		



GEBERIT MAPRESS

316 Stainless Steel Crimped Piping System



316 ST. STEEL REDUCERS

	CODE:	SIZE (OD)	PRICE
 <p>Reducer With Plain End</p>	M33002	15 x 12	
	M32305	22 x 15	
	M32307	28 x 15	
	M32309	28 x 22	
	M32310	35 x 15	
	M32312	35 x 22	
	M32313	35 x 28	
	M32314	42 x 15	
	M32316	42 x 22	
	M32317	42 x 28	
	M32318	42 x 35	
	M32319	54 x 15	
	M32321	54 x 22	
	M32322	54 x 28	
	M32323	54 x 35	
	M32324	54 x 42	
	M32331	76.1 x 54	
	M32338	88.9 x 54	
	M32339	88.9 x 76.1	
	M32345	108 x 54	
M32346	108 x 76.1		
M32348	108 x 88.9		

316 ST. STEEL UNIONS

	CODE:	SIZE (OD) mm	PRICE
 <p>Union</p> <p>Union nut made of CRNI steel</p>	M35390	15 x G 3/4"	
	M35392	22 x G 1"	
	M35393	28 x G 1 1/4"	
	M35394	35 x G 1 1/2"	
	M35395	42 x G 1 3/4"	
	M35396	54 x G 2 3/8"	

316 ST. STEEL ADAPTOR UNIONS

	CODE:	SIZE (OD) mm	PRICE		
 <p>Adaptor Union With Female Thread</p> <p>Union nut made of CRNI steel</p>	M35350	15 x Rp 1/2" x G 3/4"			
	M35357	15 x Rp 3/4" x G 3/4"			
	M35359	22 x Rp 1" x G 1"			
	M35352	22 x Rp 3/4" x G 1"			
	M35353	28 x Rp 1" x G 1 1/4"			
	M35354	35 x Rp 1 1/4" x G 1 1/2"			
	M35355	42 x Rp 1 1/2" x G 1 3/4"			
	M35356	54 x Rp 2" x G 2 3/8"			
	 <p>Adaptor Union Male Thread</p> <p>Union nut made of CRNI steel</p>	M35360		15 x R 1/2" x G 3/4"	
		M35361		15 x R 3/4" x G 3/4"	
M35366		22 x R 1" x G 1"			
M35364		22 x R 1/2" x G 1"			
M35365		22 x R 3/4" x G 1"			
M35367		28 x R 1" x G 1 1/4"			
M35368		35 x R 1 1/4" x G 1 1/2"			
M35369		42 x R 1 1/2" x G 1 3/4"			
M35370		54 x R 2" x G 2 3/8"			





316 ST. STEEL END CAPS

	CODE:	SIZE (OD)	PRICE
 <p>Cap</p>	M33212	15	
	M33214	22	
	M33215	28	
	M33216	35	
	M33217	42	
	M33218	54	
	M33219	76.1	
	M33220	88.9	
	M33221	108	

316 ST. STEEL EXPANSION FITTINGS

	CODE:	SIZE (OD) mm	PRICE
 <p>Axial Expansion Fitting With Pressing Sockets</p>	M33935	28 x 39	
	M33936	35 x 46	
	M33937	42 x 56	
	M33938	54 x 70	
	M33939	76.1 x 88	
	M33940	88.9 x 117	
	M33941	108 x 144	

316 ST. STEEL ADAPTORS





	CODE:	SIZE (OD)	PRICE
 <p>Adaptor Female Thread</p>	M31802	15 x Rp 1/2"	
	M31823	15 x Rp 3/4"	
	M31801	15 x Rp 3/8"	
	M31824	22 x Rp 1"	
	M31805	22 x Rp 1/2"	
	M31806	22 x Rp 3/4"	
	M31825	28 x Rp 1 1/4"	
	M31809	28 x Rp 1"	
	M31807	28 x Rp 1/2"	
	M31819	28 x Rp 3/4"	
	M31826	35 x Rp 1 1/2"	
	M31811	35 x Rp 1 1/4"	
	M31820	35 x Rp 1"	
	M31814	42 x Rp 1 1/2"	
	M31821	42 x Rp 1 1/4"	
	M31822	54 x Rp 1 1/2"	
	M31818	54 x Rp 2"	
 <p>Adaptor Male Thread, Plain End</p>	M31932	15 x R 1/2"	
	M31936	22 x R 3/4"	
	M31937	28 x R 1"	
	M31938	35 x R 1 1/4"	
	M31939	42 x R 1 1/2"	
	M31940	54 x R 2"	
	 <p>Adaptor Male Thread, NPT</p>	M31833	
M31837		22 x R 3/4"	
M31838		28 x R 1"	
M31839		35 x R 1 1/4"	
M31840		42 x R 1 1/2"	
M31841		54 x R 2"	
 <p>Adaptor Male Thread</p>	M31703	15 x R 1/2"	
	M31714	15 x R 3/4"	
	M31726	15 x R 3/8"	
	M31716	22 x R 1"	
	M31715	22 x R 1/2"	
	M31707	22 x R 3/4"	
	M31718	28 x R 1 1/4"	
	M31708	28 x R 1"	
	M31717	28 x R 3/4"	
	M31720	35 x R 1 1/2"	
	M31709	35 x R 1 1/4"	
	M31719	35 x R 1"	
	M31710	42 x R 1 1/2"	
	M31721	42 x R 1 1/4"	
M31722	54 x R 1 1/2"		
M31711	54 x R 2"		
M31713	76.1 x R 2 1/2"		
M31724	88.9 x R 3"		
 <p>Adaptor With Union Nut</p>	M35132	15 x G 3/4"	
	M35134	22 x G 1"	
	M35075	28 x G 1 1/2"	





■ GEBERIT MAPRESS

316 Stainless Steel Crimped Piping System







316 ST. STEEL FLANGES

	CODE:	SIZE (OD) mm	PRICE
Flange PN 10/16 Plain End 	M33748	54	
	M33749	76.1	
	M33750	88.9	
	M33752	108	
Flange PN 10/16 With Pressing Socket 	M33732	15	
	M33734	22	
	M33735	28	
	M33736	35	
	M33737	42	
	M33738	54	
	M33739	76.1	
	M33740	88.9	
	M33741	108	
Flanged Stub With Plain End For Loose Flange PN 10/16 	M36141	22	
	M36142	28	
	M36143	35	
	M36144	42	
	M36145	54	
	M36146	76.1	
	M36147	88.9	
	M36148	108	
Seal Ring CIIR, Black 	M90402	15	
	M90404	22	
	M90405	28	
	M90406	35	
	M90407	42	
	M90408	54	
	M90409	76.1	
	M90410	88.9	
	M90411	108	
Seal Ring FKM, Blue 	M90881	12	
	M90882	15	
	M90884	22	
	M90885	28	
	M90886	35	
	M90887	42	
	M90888	54	
	M90891	76.1	
	M90893	108	

316 ST. STEEL VALVES

	CODE:	SIZE (OD) mm	PRICE
316 SS Ball Valve With Lever Handle CIIR/PTFE 	M92100	15	
	M92102	22	
	M92103	28	
	M92104	35	
	M92105	42	
	M92106	54	
	M92107	76.1	
	M92108	88.9	
	M92109	108	
316 SS Non-Return Valve CIIR/PTFE 	M92140	15	
	M92142	22	
	M92143	28	
	M92144	35	
	M92145	42	
	M92146	54	
	M92147	76.1	
	M92148	88.9	
	M92149	108	

MAPRESS ST. STEEL TOOLING

	CODE:	PRICE
Mapress Starter Kit Suitable For D15-35mm incl: ACO 203 pressing tool, jaws, battery, charger, deburrer and marking tools 	MPRESSKIT	
Pressing Tool, In Case 	ACO 203 (2), AS/NZS 3112 M691.218.P6.1 ACO 203XL (2XL), AS/NZS 3112 M691.228.P6.1	
Li-Ion Battery, 18V	M690.599.00.1	
Battery Charger 18V, AS/NZS 3112	M690.598.P6.1	
Brunox Turbo-Spray	M90000	
	CODE:	SIZE (OD) mm
Pressing Jaw (2) 	M90532	15
	M90534	22
	M90535	28
	M90536	35
Pressing Collar Set (2), In Case	M691.296.00.2	42-54
Pressing Collar Set (2XL), In Case	M691.188.00.1	76.1/88.9
Pressing Collar Set (2XL), In Case	M691.189.00.1	108
Adaptor Jaw (2XL) Adaptor Jaw ZB222 (2XL)	M691.186.00.1	76.1/88.9 & 108
	M691.187.00.1	108
Case For Pressing Jaw (2),(3) 	M691.137.00.1	
Insertion Distance Template With Marker Pen 	M90351	12 - 108
Marker Pen	M90358	
Pipe Deburrer	M90363	12 - 54
Pressure Test Plug 	M90922	15
	M90924	22
	M90925	28
	M90926	35
	M90927	42
	M90928	54
	M90929	76.1
	M90930	88.9
	M90931	108
Pipe Cutter 	M91088	12 - 54
Set Of Cutting Wheels For Pipe Cutter	M91092	12 - 54