

## +GF+ Schedule 80 CPVC Hi-Temp Industrial Piping System

Plastic Systems' CPVC 'Hi-Temp' Schedule 80 piping system is a truly industrial product with special application in process pipework where high integrity and excellent chemical resistance are required.

### Chemical Resistance

CPVC (Chlorinated Polyvinyl Chloride) is particularly useful for handling corrosive fluids at temperatures up to 99°C. In chemical resistance, it is comparable to PVC. It weighs about one-sixth as much as stainless steel, will not sustain combustion (self-extinguishing) and has low thermal conductivity. Suggested uses include process piping for hot corrosive liquids, hot and cold water lines, and similar applications above the temperature range of PVC. CPVC pipe may be joined by solvent welding, threading or flanging.

### Solvent Cement Jointing

The Installation of CPVC Schedule 80 pipework should only be undertaken by suitably qualified and experienced persons. Please contact Plastic Systems for appropriate training.

Plastic Systems recommend the use of IPS-724 solvent cement when jointing CPVC Schedule 80. This has been specifically developed for use with CPVC Schedule 80 in chemical applications.

### Standards

CPVC Schedule 80 was initially developed for the American market and as such is made to the relevant ASTM Standards. Flanges are drilled to the ANSI 150 pattern and threaded fittings are NPT. Please note that this is different to the Table D/E flanges and BSP threads common to New Zealand.

### Related Documents:

- Plastic Systems Installation Guide
- IPS Weld-On Cements Price List
- Pipe Clips, Dressing Sets & Backing Rings Price List

### CPVC HI-TEMP SCHEDULE 80 PIPE - PLAIN ENDS

CODE:	Size (NB) mm	Size (NB) inch	O.D. mm	Avg. I.D. mm	Min Wall Thick. mm	Nom Wt. Kg/m	Price Per 6m Pipe
PCPVC80/008	8"	1/4"	13.7	7.2	3	0.15	
PCPVC80/010	10	3/8"	17.1	10.2	3.2	0.2	
PCPVC80/015	15	1/2"	21.3	13.4	3.7	0.31	
PCPVC80/020	20	3/4"	26.7	18.3	3.9	0.41	
PCPVC80/025	25	1"	33.4	23.7	4.5	0.61	
PCPVC80/032	32	1 1/4"	42.2	31.9	4.9	0.84	
PCPVC80/040	40	1 1/2"	48.3	37.5	5.1	1.02	
PCPVC80/050	50	2"	60.3	48.6	5.5	1.46	
PCPVC80/065	65	2 1/2"	73	58.2	7	2.15	
PCPVC80/080	80	3"	88.9	72.7	7.6	2.88	
PCPVC80/100	100	4"	114.3	96.2	8.6	4.21	
PCPVC80/125	125	5	141.3	121.11	9.5	6.16	
PCPVC80/150	150	6"	168.3	144.8	11	8.04	
PCPVC80/200	200	8"	219.1	192.2	12.7	12.22	

15 - 200mm pipe is also available in 1 metre sections - POA

PRICES INDICATED DO NOT INCLUDE GST



### Asmuss Plastic Systems Limited

FREEPHONE: 0800 000 546 Facsimile: (64) (9) 477 - 2328  
 sales@plasticsystems.co.nz  
 34 Arrenway Drive, North Shore City 0632  
 P.O. Box 100244, North Shore City 0745, Auckland, NZ



Pipe • Fittings • Valving • Measurement & Control

[www.plasticsystems.co.nz](http://www.plasticsystems.co.nz)

# +GF+ Schedule 80 CPVC

## Hi-Temp Industrial Pipe Fittings

### CPVC SCH80 TEES

	CODE:	SIZE (NB)		PRICE
<b>CPVC SCH80 TEE PLAIN (9801)</b> 	FCPVCTEE/015	15mm	½"	
	FCPVCTEE/020	20mm	¾"	
	FCPVCTEE/025	25mm	1"	
	FCPVCTEE/032	32mm	1¼"	
	FCPVCTEE/040	40mm	1½"	
	FCPVCTEE/050	50mm	2"	
	FCPVCTEE/065	65mm	2½"	
	FCPVCTEE/080	80mm	3"	
	FCPVCTEE/100	100mm	4"	
	FCPVCTEE/150	150mm	6"	
	FCPVCTEE/200	200mm	8"	

### CPVC SCH80 90° ELBOWS

	CODE:	SIZE (NB)		PRICE
<b>CPVC SCH80 ELBOW 90 DEG PLAIN (9806)</b> 	FCPVCEL90/015	15mm	½"	
	FCPVCEL90/020	20mm	¾"	
	FCPVCEL90/025	25mm	1"	
	FCPVCEL90/032	32mm	1¼"	
	FCPVCEL90/040	40mm	1½"	
	FCPVCEL90/050	50mm	2"	
	FCPVCEL90/065	65mm	2½"	
	FCPVCEL90/080	80mm	3"	
	FCPVCEL90/100	100mm	4"	
	FCPVCEL90/150	150mm	6"	
	FCPVCEL90/200	200mm	8"	



### CPVC SCH80 45° ELBOWS

	CODE:	SIZE (NB)		PRICE
<b>CPVC SCH80 ELBOW 45 DEG PLAIN (9817)</b> 	FCPVCEL45/010	10mm	⅜"	
	FCPVCEL45/015	15mm	½"	
	FCPVCEL45/020	20mm	¾"	
	FCPVCEL45/025	25mm	1"	
	FCPVCEL45/032	32mm	1¼"	
	FCPVCEL45/040	40mm	1½"	
	FCPVCEL45/050	50mm	2"	
	FCPVCEL45/065	65mm	2½"	
	FCPVCEL45/080	80mm	3"	
	FCPVCEL45/100	100mm	4"	
	FCPVCEL45/150	150mm	6"	
	FCPVCEL45/200	200mm	8"	

### CPVC SCH80 90° BENDS

	CODE:	SIZE (NB)		PRICE
<b>CPVC SCH80 SWEEP 90 DEG BEND</b>	FCPVCEB90/015	15mm	½"	
	FCPVCEB90/020	20mm	¾"	
	FCPVCEB90/025	25mm	1"	
	FCPVCEB90/032	32mm	1¼"	
	FCPVCEB90/040	40mm	1½"	
	FCPVCEB90/050	50mm	2"	
	FCPVCEB90/080	80mm	3"	
	FCPVCEB90/100	100mm	4"	

### CPVC SCH80 SOCKETS

	CODE:	SIZE (NB)		PRICE
<b>CPVC SCH80 SOCKET PLAIN (9829)</b> 	FCPVCSOP/008	8mm	¼"	
	FCPVCSOP/010	10mm	⅜"	
	FCPVCSOP/015	15mm	½"	
	FCPVCSOP/020	20mm	¾"	
	FCPVCSOP/025	25mm	1"	
	FCPVCSOP/032	32mm	1¼"	
	FCPVCSOP/040	40mm	1½"	
	FCPVCSOP/050	50mm	2"	
	FCPVCSOP/065	65mm	2½"	
	FCPVCSOP/080	80mm	3"	
	FCPVCSOP/100	100mm	4"	
	FCPVCSOP/150	150mm	6"	
	FCPVCSOP/200	200mm	8"	
	FCPVCSOP/250	250mm	10"	
	<b>CPVC SCH80 PLAIN/ THREADED NPT SOCKET (9835)</b> 	FCPVCSOPT/015	15mm	½"
FCPVCSOPT/020		20mm	¾"	
FCPVCSOPT/025		25mm	1"	
FCPVCSOPT/032		32mm	1¼"	
FCPVCSOPT/040		40mm	1½"	
FCPVCSOPT/050		50mm	2"	
FCPVCSOPT/080	80mm	3"		
FCPVCSOPT/100	100mm	4"		

NPT Thread

### CPVC SCH80 SOCKET UNIONS

	CODE:	SIZE (NB)		PRICE
<b>CPVC SCH80 SOCKET UNION PLAIN FPM (9897)</b> 	FCPVCSOUN/008	8mm	¼"	
	FCPVCSOUN/010	10mm	⅜"	
	FCPVCSOUN/015	15mm	½"	
	FCPVCSOUN/020	20mm	¾"	
	FCPVCSOUN/025	25mm	1"	
	FCPVCSOUN/032	32mm	1¼"	
	FCPVCSOUN/040	40mm	1½"	
	FCPVCSOUN/050	50mm	2"	
	FCPVCSOUN/080	80mm	3"	
	FCPVCSOUN/100	100mm	4"	

FPM O-Ring

### CPVC SCH80 END CAPS

	CODE:	SIZE (NB)		PRICE
<b>CPVC SCH80 PLAIN CAP (9847)</b> 	FCPVCCAP/015	15mm	½"	
	FCPVCCAP/020	20mm	¾"	
	FCPVCCAP/025	25mm	1"	
	FCPVCCAP/032	32mm	1¼"	
	FCPVCCAP/040	40mm	1½"	
	FCPVCCAP/050	50mm	2"	
	FCPVCCAP/065	65mm	2½"	
	FCPVCCAP/080	80mm	3"	
	FCPVCCAP/100	100mm	4"	
	FCPVCCAP/150	150mm	6"	
FCPVCCAP/200	200mm	8"		

### CPVC PLAIN FLANGES

	CODE:	SIZE (NB)		PRICE	
	<b>CPVC SCH80 FLANGE PLAIN</b>	FCPVCFLPL150/015	15mm	½"	
		FCPVCFLPL150/020	20mm	¾"	
		FCPVCFLPL150/025	25mm	1"	
	<b>ANSI 150 (9851)</b>	FCPVCFLPL150/032	32mm	1¼"	
		FCPVCFLPL150/040	40mm	1½"	
		FCPVCFLPL150/050	50mm	2"	
		FCPVCFLPL150/065	65mm	2½"	
		FCPVCFLPL150/080	80mm	3"	
		FCPVCFLPL150/100	100mm	4"	
		FCPVCFLPL150/150	150mm	6"	
		FCPVCFLPL150/200	200mm	8"	



### CPVC SCH80 BLANK FLANGES

	CODE:	SIZE (NB)		PRICE	
	<b>CPVC SCH80 FLANGE BLANK</b>	FCPVCFLB150/015	15mm	½"	
		FCPVCFLB150/020	20mm	¾"	
		FCPVCFLB150/025	25mm	1"	
	<b>ANSI 150 (9853)</b>	FCPVCFLB150/032	32mm	1¼"	
		FCPVCFLB150/040	40mm	1½"	
		FCPVCFLB150/050	50mm	2"	
		FCPVCFLB150/065	65mm	2½"	
		FCPVCFLB150/080	80mm	3"	
		FCPVCFLB150/100	100mm	4"	
		FCPVCFLB150/150	150mm	6"	
		FCPVCFLB150/200	200mm	8"	

### CPVC SCH80 VAN STONE FLANGES

	CODE:	SIZE (NB)		PRICE	
	<b>CPVC SCH80 VAN STONE FLANGE</b>	FCPVCFLVS150/015	15mm	½"	
		FCPVCFLVS150/020	20mm	¾"	
		FCPVCFLVS150/025	25mm	1"	
	<b>ANSI 150 (9854)</b>	FCPVCFLVS150/032	32mm	1¼"	
		FCPVCFLVS150/040	40mm	1½"	
		FCPVCFLVS150/050	50mm	2"	
		FCPVCFLVS150/065	65mm	2½"	
		FCPVCFLVS150/080	80mm	3"	
		FCPVCFLVS150/100	100mm	4"	
		FCPVCFLVS150/150	150mm	6"	
		FCPVCFLVS150/200	200mm	8"	
	<b>CPVC SCH80 SPIGOT VAN STONE FLANGE ANSI 150</b>	FCPVCFLVSSP/015	15mm	½"	
FCPVCFLVSSP/020		20mm	¾"		
FCPVCFLVSSP/025		25mm	1"		
FCPVCFLVSSP/032		32mm	1¼"		
FCPVCFLVSSP/040		40mm	1½"		
FCPVCFLVSSP/050		50mm	2"		
FCPVCFLVSSP/065		65mm	2½"		
FCPVCFLVSSP/080		80mm	3"		
FCPVCFLVSSP/100		100mm	4"		
FCPVCFLVSSP/150		150mm	6"		
<b>CPVC SCH80 VAN STONE FLANGE DIN</b>	FCPVCFLVSDIN/080	80mm	3"		
	FCPVCFLVSDIN/100	100mm	4"		
<b>CPVC SCH80 VAN STONE FLANGE UNIVERSAL</b>	FCPVCFLVSU/050	50mm	2"		
	FCPVCFLVSU/150	150mm	6"		

### CPVC SCH80 ADAPTORS

	CODE:	SIZE (NB)		PRICE	
	<b>CPVC SCH80 FEMALE ADAPTOR NPT (9878)</b>	FCPVCFMADPT/015	15mm	½"	
		FCPVCFMADPT/020	20mm	¾"	
		FCPVCFMADPT/025	25mm	1"	
		FCPVCFMADPT/032	32mm	1¼"	
		FCPVCFMADPT/040	40mm	1½"	
		FCPVCFMADPT/050	50mm	2"	
		FCPVCFMADPT/080	80mm	3"	
	<b>CPVC SCH80 MALE ADAPTOR NPT (9836)</b>	FCPVCMAADPT/015	15mm	½"	
		FCPVCMAADPT/020	20mm	¾"	
		FCPVCMAADPT/025	25mm	1"	
		FCPVCMAADPT/032	32mm	1¼"	
		FCPVCMAADPT/040	40mm	1½"	
		FCPVCMAADPT/050	50mm	2"	
		FCPVCMAADPT/080	80mm	3"	
		FCPVCMAADPT/100	100mm	4"	

### CPVC SCH80 PLUGS

	CODE:	SIZE (NB)		PRICE		
	<b>CPVC SCH80 PLUG NPT (9850)</b>	FCPVCPLUGNPT/008	8mm	¼"		
		FCPVCPLUGNPT/010	10mm	⅜"		
		FCPVCPLUGNPT/015	15mm	½"		
		FCPVCPLUGNPT/020	20mm	¾"		
		FCPVCPLUGNPT/025	25mm	1"		
		FCPVCPLUGNPT/040	40mm	1½"		
		FCPVCPLUGNPT/050	50mm	2"		
		FCPVCPLUGNPT/100	100mm	4"		



### CPVC HOSETAILS

	CODE:	SIZE (NB)		PRICE
<b>CPVC HOSETAIL NPT</b>	FCPVCHOADPT/015	15mm	½"	
	FCPVCHOADPT/020	20mm	¾"	
	FCPVCHOADPT/025	25mm	1"	
	FCPVCHOADPT/032	32mm	1¼"	
	FCPVCHOADPT/040	40mm	1½"	
	FCPVCHOADPT/050	50mm	2"	

Not Schedule 80

Refer to Pipe Clips, Dressing Sets & Backing Rings price list for full range.

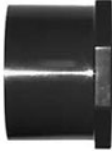
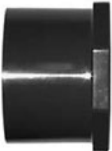
### CPVC REDUCING BUSHES

	CODE:	SIZE (NB)	PRICE	
<b>CPVC SCH80 REDUCING BUSH PLAIN (9837)</b> 	FCPVCBP/010x008	10x8mm	3/8 x 1/4"	
	FCPVCBP/015x008	15x8mm	1/2 x 1/4"	
	FCPVCBP/015x010	15x10mm	1/2 x 3/8"	
	FCPVCBP/020x015	20x15mm	3/4 x 1/2"	
	FCPVCBP/025x015	25x15mm	1 x 1/2"	
	FCPVCBP/025x020	25x20mm	1 x 3/4"	
	FCPVCBP/032x015	32x15mm	1 1/4 x 1/2"	
	FCPVCBP/032x020	32x20mm	1 1/4 x 3/4"	
	FCPVCBP/032x025	32x25mm	1 1/4 x 1"	
	FCPVCBP/040x015	40x15mm	1 1/2 x 1/2"	
	FCPVCBP/040x020	40x20mm	1 1/2 x 3/4"	
	FCPVCBP/040x025	40x25mm	1 1/2 x 1"	
	FCPVCBP/040x032	40x32mm	1 1/2 x 1 1/4"	
	FCPVCBP/050x015	50x15mm	2 x 1/2"	
	FCPVCBP/050x020	50x20mm	2 x 3/4"	
	FCPVCBP/050x025	50x25mm	2 x 1"	
	FCPVCBP/050x032	50x32mm	2 x 1 1/4"	
	FCPVCBP/050x040	50x40mm	2 x 1 1/2"	
	FCPVCBP/065x040	65x40mm	2 1/2 x 1 1/2"	
	FCPVCBP/065x050	65x50mm	2 1/2 x 2"	
	FCPVCBP/080x040	80x40mm	3 x 1 1/2"	
	FCPVCBP/080x050	80x50mm	3 x 2"	
	FCPVCBP/080x065	80x65mm	3 x 2 1/2"	
	FCPVCBP/100x050	100x50mm	4 x 2"	
	FCPVCBP/100x080	100x80mm	4 x 3"	
FCPVCBP/150x100	150x100mm	6 x 4"		
FCPVCBP/200x150	200x150mm	8 x 6"		
<b>CPVC SCH80 REDUCING BUSH PLAIN/ THREADED NPT (9838)</b> 	FCPVCBT/010x008	10x8mm	3/8 x 1/4"	
	FCPVCBT/015x008	15x8mm	1/2 x 1/4"	
	FCPVCBT/015x010	15x10mm	1/2 x 3/8"	
	FCPVCBT/020x008	20x8mm	3/4 x 1/4"	
	FCPVCBT/020x015	20x15mm	3/4 x 1/2"	
	FCPVCBT/025x015	25x15mm	1 x 1/2"	
	FCPVCBT/025x020	25x20mm	1 x 3/4"	
	FCPVCBT/032x015	32x15mm	1 1/4 x 1/2"	
	FCPVCBT/032x020	32x20mm	1 1/4 x 3/4"	
	FCPVCBT/032x025	32x25mm	1 1/4 x 1"	
	FCPVCBT/040x015	40x15mm	1 1/2 x 1/2"	
	FCPVCBT/040x020	40x20mm	1 1/2 x 3/4"	
	FCPVCBT/040x025	40x25mm	1 1/2 x 1"	
	FCPVCBT/040x032	40x32mm	1 1/2 x 1 1/4"	
	FCPVCBT/050x015	50x15mm	2 x 1/2"	
	FCPVCBT/050x020	50x20mm	2 x 3/4"	
	FCPVCBT/050x025	50x25mm	2 x 1"	
	FCPVCBT/050x032	50x32mm	2 x 1 1/4"	
	FCPVCBT/050x040	50x40mm	2 x 1 1/2"	
	FCPVCBT/065x050	65x50mm	2 1/2 x 2"	
	FCPVCBT/080x050	80x50mm	3 x 2"	
	FCPVCBT/080x065	80x65mm	3 x 2 1/2"	
	FCPVCBT/100x050	100x50mm	4 x 2"	
	FCPVCBT/100x050	100x80mm	4 x 3"	
	NPT Thread			
<b>CPVC SCH80 REDUCING BUSH NPT (9839)</b> 	FCPVCBN/010X008	10x8mm	3/8 x 1/4"	
	FCPVCBN/015X008	15x8mm	1/2 x 1/4"	
	FCPVCBN/015X010	15x10mm	1/2 x 3/8"	
	FCPVCBN/020X015	20x15mm	3/4 x 1/2"	
	FCPVCBN/025X015	25x15mm	1 x 1/2"	
	FCPVCBN/025X020	25x20mm	1 x 3/4"	
	FCPVCBN/032X025	32x25mm	1 1/4 x 1"	
	FCPVCBN/040X025	40x25mm	1 1/2 x 1"	
	FCPVCBN/040X032	40x32mm	1 1/2 x 1 1/4"	
	FCPVCBN/050X020	50x20mm	2 x 3/4"	
	FCPVCBN/050X040	50x40mm	2 x 1 1/2"	
	FCPVCBN/065X050	65x50mm	2 1/2 x 2"	
	FCPVCBN/080X050	80x50mm	3 x 2"	
	FCPVCBN/100X050	100x50mm	4 x 2"	
	NPT Thread			

### CPVC SCH80 REDUCING SOCKETS

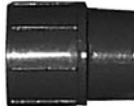
	CODE:	SIZE (NB)	PRICE
<b>CPVC SCH80 REDUCING SOCKET (9829)</b> 	FCPVCRS/020x015	20x15mm	3/4 x 1/2"
	FCPVCRS/025x015	25x15mm	1 x 1/2"
	FCPVCRS/025x020	25x20mm	1 x 3/4"
	FCPVCRS/032x025	32x25mm	1 1/4 x 1"
	FCPVCRS/040x025	40x25mm	1 1/2 x 1"
	FCPVCRS/040x032	40x32mm	1 1/2 x 1 1/4"
	FCPVCRS/050x025	50x25mm	2 x 1"
	FCPVCRS/050x040	50x40mm	2 x 1 1/2"
	FCPVCRS/065x050	65x50mm	2 1/2 x 2"
	FCPVCRS/080x050	80x50mm	3 x 2"
	FCPVCRS/100x050	100x50mm	4 x 2"
	FCPVCRS/100x080	100x80mm	4 x 3"
	FCPVCRS/150x100	150x100mm	6 x 4"
	FCPVCRS/300x250	300x250mm	12 x 10"

### CPVC SCH80 NIPPLES

	CODE:	SIZE (NB)	PRICE	
<b>CPVC SCH80 NIPPLE PLAIN/ THREADED BSP MACHINED</b>	FCPVCNIPTBSP/015	15mm	1/2"	
	FCPVCNIPTBSP/020	20mm	3/4"	
	FCPVCNIPTBSP/025	25mm	1"	
	FCPVCNIPTBSP/032	32mm	1 1/4"	
	FCPVCNIPTBSP/040	40mm	1 1/2"	
	FCPVCNIPTBSP/050	50mm	2"	
	FCPVCNIPTBSP/080	80mm	3"	
	FCPVCNIPTBSP/100	100mm	4"	
	BSP Thread			

### CPVC SCH80 TANK ADAPTERS

	CODE:	SIZE (NB)	PRICE
<b>CPVC SCH80 TANK ADAPTOR EPDM</b>	FCPVCTAEPDM/015	15mm	1/2"
	FCPVCTAEPDM/020	20mm	3/4"
	FCPVCTAEPDM/025	25mm	1"
	FCPVCTAEPDM/032	32mm	1 1/4"
	FCPVCTAEPDM/040	40mm	1 1/2"
	FCPVCTAEPDM/050	50mm	2"
	FCPVCTAEPDM/080	80mm	3"
	<b>CPVC SCH80 TANK ADAPTOR FPM</b>	FCPVCTAFPM/015	15mm
FCPVCTAFPM/020		20mm	3/4"
FCPVCTAFPM/025		25mm	1"
FCPVCTAFPM/032		32mm	1 1/4"
FCPVCTAFPM/040		40mm	1 1/2"
FCPVCTAFPM/050		50mm	2"
FCPVCTAFPM/080		80mm	3"

### PIPE CLIPS

	CODE:	SIZE (NB)	PRICE
<b>Pipe Clips</b> 	167061086	15mm	1/2"
	167061087	20mm	3/4"
	167061088	25mm	1"
	167061089	32mm	1 1/4"
	167061090	40mm	1 1/2"
	167061091	50mm	2"
	167061112	65mm	2 1/2"
	FPCI/080	80mm	3"
	FPCI/100	100mm	4"
	FPCI/150	150mm	6"
	FPCI/200	200mm	8"
**Refer to Pipe Clips price list for current pricing			

Refer to Pipe Clips, Dressing Sets & Backing Rings price list for full range.